



PELLET STOVE

HALO AIR 8 M1

PART 2 - OPERATION AND CLEANING

Instructions in English

MCZ

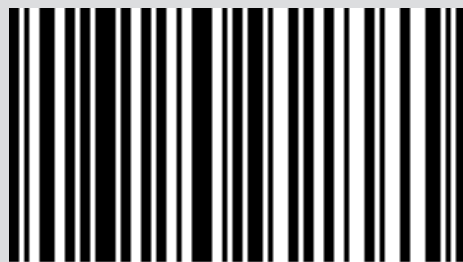

8901855100

TABLE OF CONTENTS

TABLE OF CONTENTS	II
10-FIRST START-UP	3
11-SYSTEM REQUIREMENTS.....	4
12-FIRST APP START-UP AND ASSOCIATION WITH MCZ STOVES	5
13-STOVE ACCESSORY CONFIGURATION	8
14-COMFORT SETTING.....	10
15-EMERGENCY PANEL.....	13
16-EMERGENCY PANEL FUNCTIONS.....	14
17-MANUAL CONFIGURATION	15
18-APP FUNCTIONS.....	16
19-SIDE DROP DOWN MENU	18
20-SHORTCUTS SETTINGS / RAPID SETTINGS.....	19
21-SET FACTORY PARAMETERS.....	23
22-OPERATION MENU.....	28
23-SETTINGS MENU	31
24-SOFTWARE VERSION	37
25-TECHNICAL MENU	38
26-INFO MENU.....	40
27-SAFETY DEVICES	41
28-ALARMS	42
29-RECOMMENDATIONS FOR SAFE USE	48
30-CLEANING	49
31-TROUBLESHOOTING	58
32-CIRCUIT BOARD	61

10-FIRST START-UP

WARNINGS BEFORE IGNITION

GENERAL WARNINGS

Remove all parts that may burn from the brazier and the glass (manual, various adhesive labels or any polystyrene).

Check that the brazier is positioned correctly and rests properly on the base.



The first start-up may not be successful as the feed screw is empty and does not always manage to load the brazier with the required amount of pellets in time to light the flame.



**CLEAR THE FAILED IGNITION ALARM FROM THE STOVE PANEL OR APP.
REMOVE THE PELLETS LEFT IN THE BRAZIER AND REPEAT IGNITION. (SEE "SAFETY DEVICES/ALARMS" PARAGRAPH)**

If, after repeated attempts, the flame fails to ignite, despite a regular flow of pellets, check the correct positioning of the brazier, which **must rest snugly against the slots**. If no anomaly is found during this inspection, there may be a problem with the product components or installation may not be correct.



REMOVE THE PELLETS FROM THE BRAZIER AND CONTACT AN AUTHORISED TECHNICIAN.



Do not touch the stove during the first start-up, as it is during this phase that the paint sets. If you touch the paint, you may expose the steel surface.



It is good practice to ensure effective ventilation in the room during the initial start-up, as the stove will emit some smoke and smell of paint.

If necessary, touch up the paint with the spray can of the specific colour.

Do not stand close to the stove and, as mentioned, air out the room. The smoke and smell of paint will disappear after about an hour of operation, however, they are not harmful in any case.



The product will be subject to expansion and contraction during the start-up and cooling stages, therefore slight creaking noises may be heard. This is absolutely normal and must not be considered a defect as the structure is made of laminated steel.

Upon **first ignition**, for the first pellet hopper, it is recommended to start the stove at maximum power so that the structure and the smell of the paint settle more quickly.

It is recommended to install the ceramic or serpentine stone cladding after the first successful ignition.



DO NOT EXPECT HEATING EFFICIENCY IMMEDIATELY!!!

11-SYSTEM REQUIREMENTS

APP

The **MCZ Maestro** App is already available on the “Handheld remote control” accessory or will be available in various playstores.

STOVE

Equipped with MAESTRO system

OPERATION

For the utmost versatility of use, two Wi-Fi modules have been designed, supporting priority connection with your smartphone and/or handheld remote control (optional).

The stove's operating status, room temperature, operating parameters (such as ventilation, power, etc.) and any alarms may be checked remotely.



Attention!

The App is already available in English on the “Handheld remote control” accessory as the language used on the telephone is set by default. If the App is downloaded onto a personal smartphone, it similarly adopts the language already in use on the phone. In either case, it is possible to open the “LANGUAGE” screen in the app and select the desired language.

12-FIRST APP START-UP AND ASSOCIATION WITH MCZ STOVES

The app lets you communicate with MCZ stoves using two technologies:

- home Wi-Fi
- remote Wi-Fi

HOME WI-FI

Point-to-point connection between the telephone and the stove, to communicate with the stove without relying on routers or internet connections. This is possible when the telephone and stove are located nearby (we recommend max 5 metres). The range of action depends on the characteristics of the walls and how the home is structured.

REMOTE WI-FI

Connection between the app and stove using an internet connection. With this technology you can communicate with the stove from anywhere. Near the stove there must be a Wi-Fi router providing an internet connection and the mobile phone in turn must have a data connection.

The first time you start the app without having configured any devices, the app opens displaying the "device list" screen.

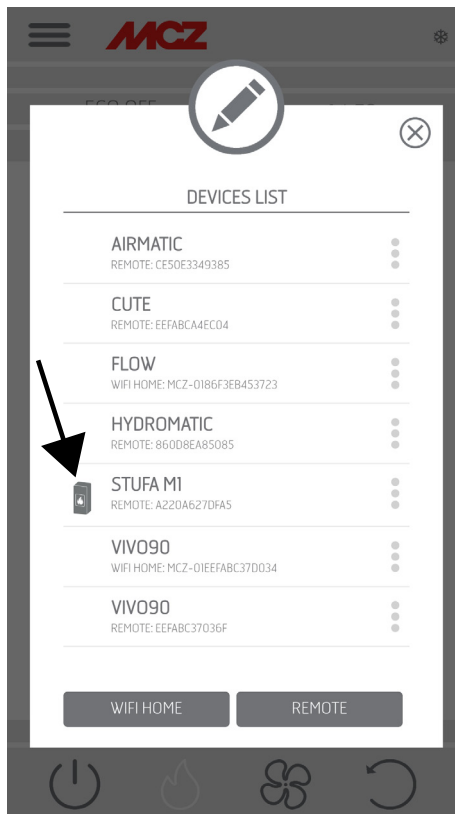

There are two ways to associate MCZ devices:

- automatically
- manually

12-FIRST APP START-UP AND ASSOCIATION WITH MCZ STOVES



IMPORTANT!! Do not lose or remove the QR code from the stove. If the stove is reset and/or the smartphone and/or handheld remote control are changed, you must have the QR code and passwords available to configure the system.

AUTOMATIC MODE

The QR code and the passwords are located at the back of the stove and in the warranty.



Home: 123456789012345678
PW D: passwordaa
S/N: 1709110060002
MAC: 123456789012

EXAMPLE OF QR AND PASSWORD LABEL

Scan the QR code using the camera of the device (accessory or smartphone) and acquire it.

When the code is acknowledged, the app will ask you to enter an identification number for the stove (for example "living room stove") to easily identify the stove/s in the list of configured devices.

This will automatically configure the app to work with both home WI-FI and remote WI-FI technology.

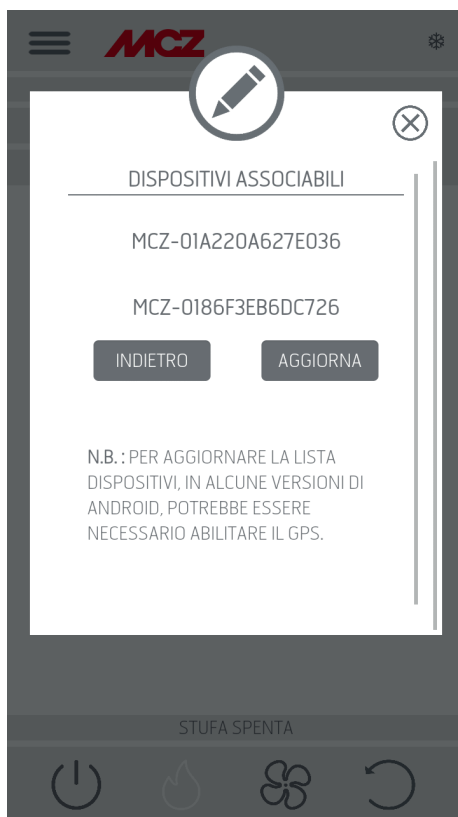
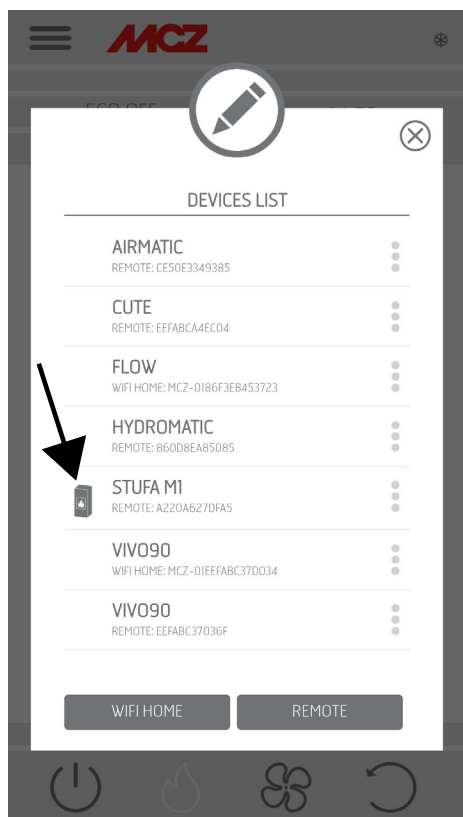

12-FIRST APP START-UP AND ASSOCIATION WITH MCZ STOVES

MANUAL MODE

The QR code and the passwords are located at the back of the stove and in the warranty. In this case, the codes must be used.



Home: 123456789012345678
PWD: passwordata
S/N: 1709110060002
MAC: 123456789012

EXAMPLE OF QR AND PASSWORD LABEL

If the stove cannot be configured using the QR code, it can be done using the DIRECT or REMOTE key.

To configure operation in HOME WI-FI mode, click on the "DIRECT" key and the "select device" screen opens. The stoves nearby are scanned; select your stove and enter the password (located near the QR code at the top) and a stove identification name (for example "living room stove") to easily identify the stove/s in the list of configured devices.

To configure operation in REMOTE WI-FI mode, click on the "REMOTE" key and the "SELECT DEVICE" screen opens. Fill in all the fields with the codes on the label (near the QR code at the bottom) and a stove identification name (for example "living room stove") to easily identify the stove/s in the list of configured devices.

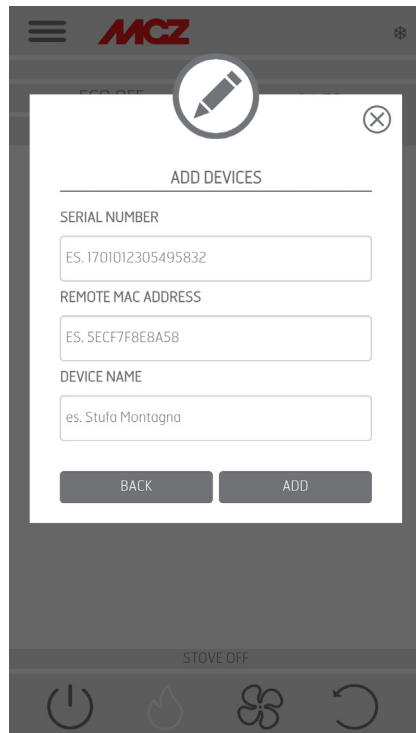
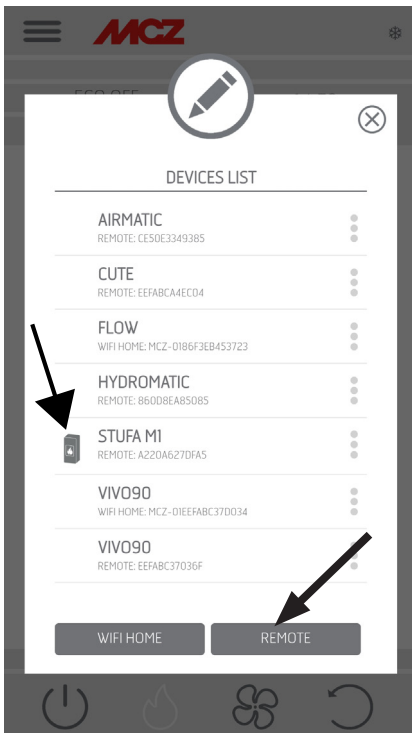

13-STOVE ACCESSORY CONFIGURATION

Once the app has been configured, you can communicate with the stove in Home mode and also configure stove accessories from the app:

- REMOTE WI-FI module (if any)
- WI-FI temperature probe (not supplied)

In order to configure the accessories, the mobile phone must be near the accessories.

CONFIGURATION OF REMOTE WI-FI MODULE FROM MCZ MAESTRO APP

To do this, connect to the stove in home mode through the app. From the “settings” / “basic settings” menu, select the configure accessories item: if there are still accessories to be configured, the two keys can be selected.

click configure remote ----- a screen opens, displaying nearby Wi-Fi routers. Select the router providing the internet connection and enter the respective password. From now on, if the router provides a stable internet connection, it is possible to command the stove remotely.

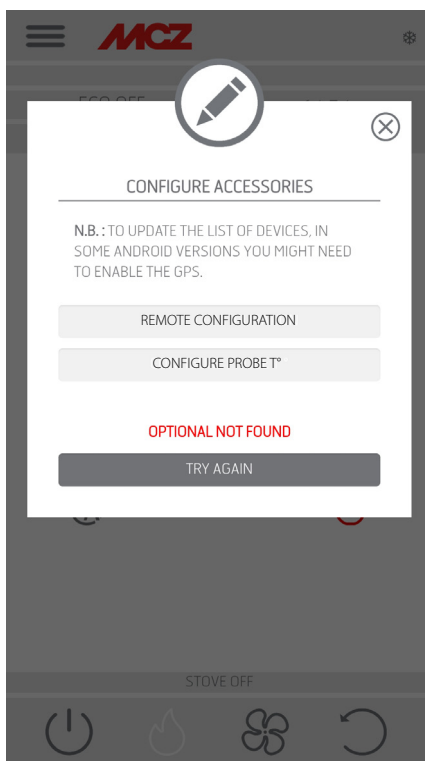
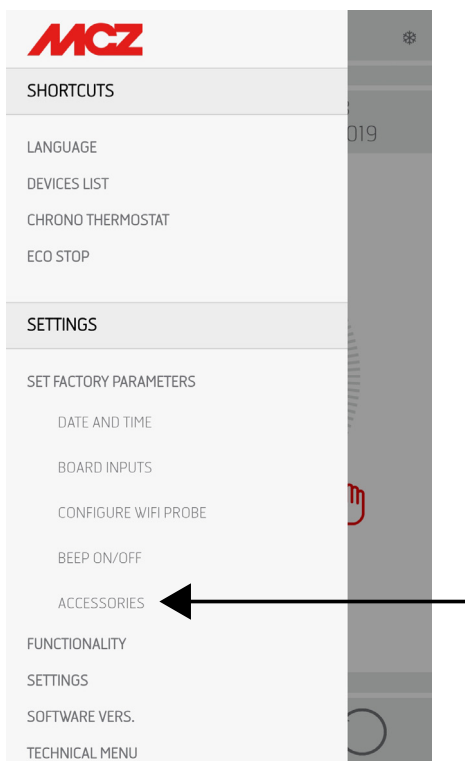

The access password to the network by the Maestro App must have a maximum of 32 characters. For longer passwords, for example generated automatically by the router upon initial installation, the length must be modified according to the procedures for your router.

Additional functions

Once the remote stove Wi-Fi module has been connected to the home router, every time the router is available, the remote stove Wi-Fi module will reconnect automatically.

If the router is replaced or the password is changed, the remote stove Wi-Fi module will revert to configuration mode as it can no longer connect.

The WI-FI modules have an auto-reset mechanism.

13-STOVE ACCESSORY CONFIGURATION

CONFIGURATION OF WI-FI TEMPERATURE PROBE FROM MCZ MAESTRO APP

The Wi-Fi temperature probe (ACCESSORY) is supplied without batteries. From when the batteries are inserted, the probe can be configured within the next 8 minutes. Therefore insert the three AA batteries shortly before you are ready to proceed with the configuration.

Then:

- insert two batteries immediately, then insert the third after placing the sensor next to the Wi-Fi emergency panel (approximately 2 cm)
- wait for the beep-beep indicating that pairing has successfully occurred (it must occur within 10")
- connect to the stove through the app in home mode
- access the settings - basic settings - accessories menu - selecting the configure accessories item

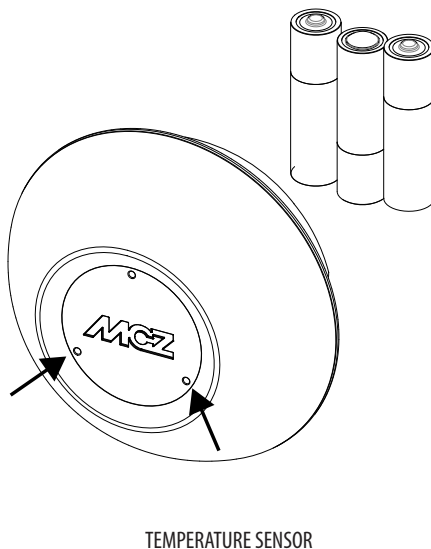
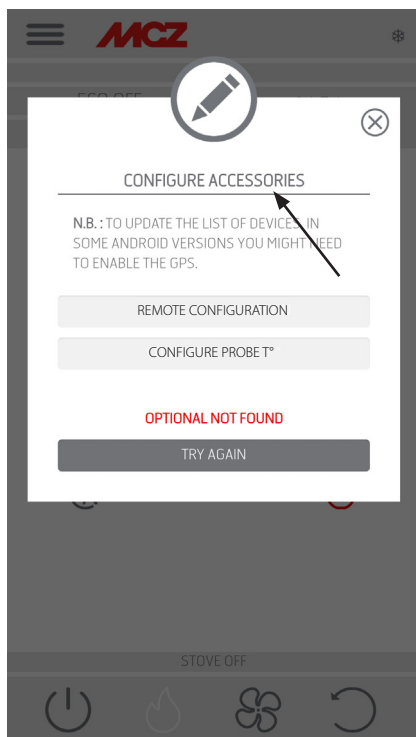

If the Wi-Fi temperature probe is available for configuration, the key can be selected, while if the key stays disabled check that the probe batteries are charged, or check that the maximum available time has not elapsed.

In this case, remove the batteries and put them back in, or press the reset button by inserting a paper clip in the hole to the right of the sensor dome. From this time on, the 8 minutes for configuration start over again.

If the probe is ready for configuration click the key in the app screen, click **T° probe configuration** ----- the screen will show the stoves that the Wi-Fi probe can be associated with; select your stove and enter the home Wi-Fi password (see QR code label).

Once the Wi-Fi probe is connected, you can configure the stove to use the remote sensor; to do this use the shortcut by clicking on the temperature indicator at the top right of the app screen and select the "Wi-Fi probe" as the temperature input. Or from the setup menu choose to configure ambient input and select the "Wi-Fi probe" temperature input.



Should it be necessary to reset the Wi-Fi probe, because already coupled to another device or configured incorrectly, use two paper clips. With the first one, press and hold the key below the bottom left hole and with the other one, press the key below the right hole once.

Repeat the configuration procedure indicated at the start of the page.

14-COMFORT SETTING

Maestro technology allows the heater to express its utmost potential with even an easier and more intuitive use. A real integrated micro-computer communicates with your smartphone and further improves the performance of the heater that continues to work perfectly even in non-ideal conditions.

The new App has 2 preset settings making stove management even easier, the consumption of the fuel is optimised and improves the comfort of use, as it can reach extremely quiet operation.

The available settings are:

DYNAMIC If you prefer traditional automatic operation with the option of setting the temperature and ventilation.

MANUAL For those who prefer to use the product in the traditional manner without any temperature control. In this mode the user can freely choose the mix of flame power and ventilation regardless of consumption or silence.

	Quiet operation *	Comfort**	Heating capacity	Reduced consumption
DYNAMIC	● ● ● ○ ○	● ● ● ○ ○	● ● ● ● ○	● ● ● ○ ○
MANUAL	● ○ ○ ○ ○	● ○ ○ ○ ○	● ● ● ● ○	● ● ○ ○ ○

* In operation, during start-up and shutdown

** Gradual heat emission, glass cleaning and combustion chamber cleaning

14-COMFORT SETTING

MANUAL SETTING

The MANUAL setting can be selected by typing the relative symbol in the screen that is also highlighted through the notches on the selection ring.

The user has the ability to manage ventilation and power.

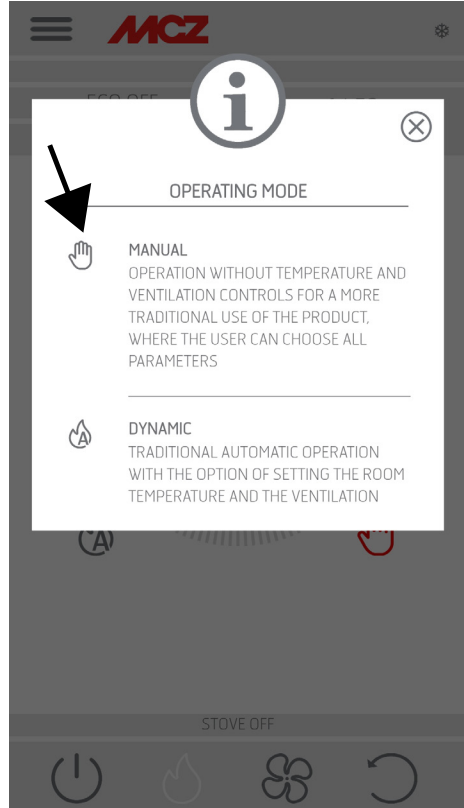

To set the desired parameters, press the temperature at the centre of the circle, and the pop-up appears to make the setting.

14-COMFORT SETTING

SET DYNAMIC

The DYNAMIC setting can be selected by typing the relative symbol in the screen that is also highlighted through the notches on the selection ring.

The user has the possibility to manage ventilation and temperature.

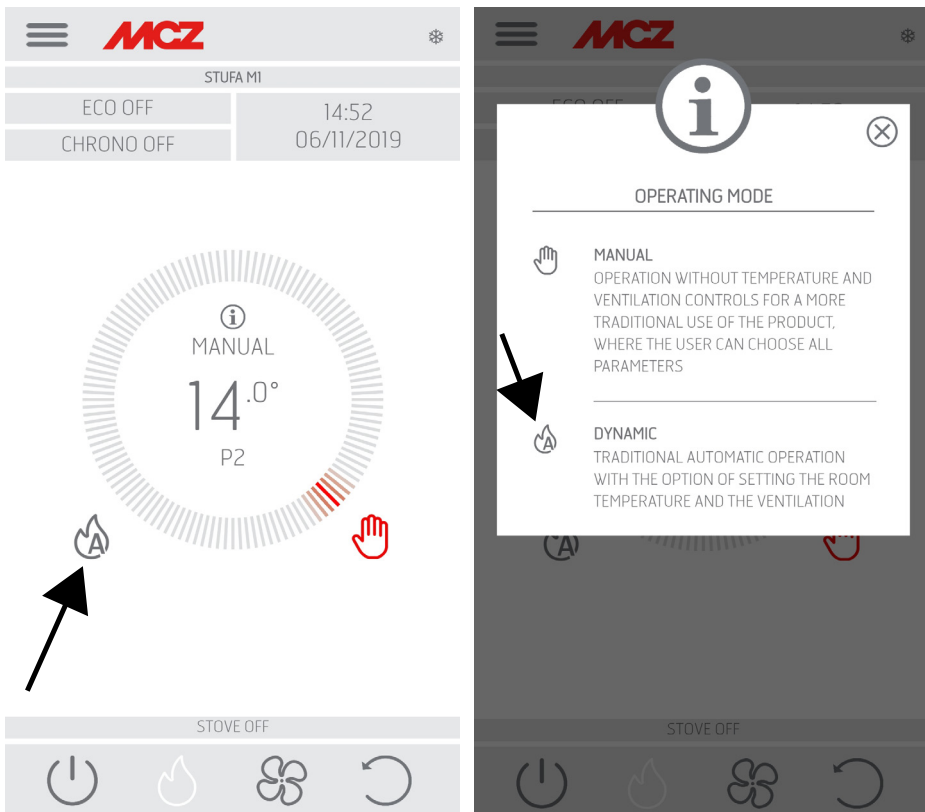

To set the desired temperature, press the temperature at the centre of the circle, and the pop-up appears to make the setting.

15-EMERGENCY PANEL

At the back of the stove, there is the emergency panel that provides some information about the stove status.

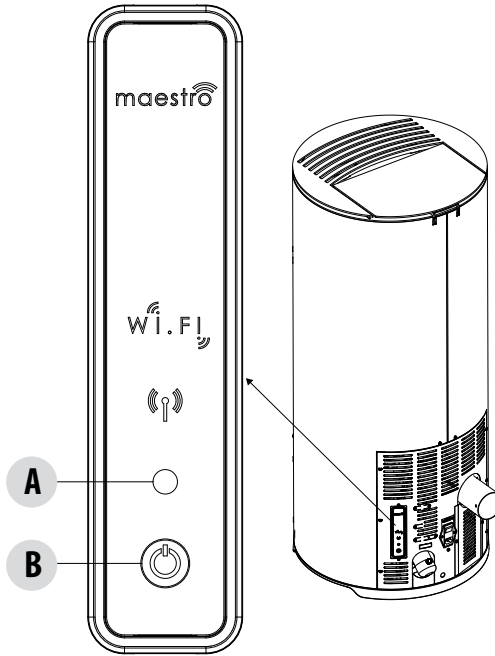

KEY

A - MULTICOLOUR LED

Green LED that indicates:

- Stove in OPERATION

Red LED that indicates:

- Stove OFF

Blue LED that indicates:

- Stove START-UP

Yellow LED that indicates:

- Stove cooling for SHUTDOWN

Flashing red LED that indicates:

- Stove in ALARM conditions

B - BUTTON - functions

Turns the product ON

Turns the product OFF

Changes the operating POWER:

- 1 beep = LOW
- 3 beeps = MEDIUM
- 5 beeps = HIGH

ALARM RESET

16-EMERGENCY PANEL FUNCTIONS

The emergency panel provides the following information:

- through a multicolour LED (A) it provides information about the stove status (off-starting-up-in operation-cooling for shutdown-in error conditions)
 - using the button (B) the following functions can be activated:
 - if the product triggered an error ----- reset the error by pressing the key for more than 3 seconds
- Attention! Alarms A01, A02, A03, A05 and A21 can only be reset from the panel and not from the app.**
- if the product is off ----- switch it on (press the key for more than 3 seconds)
 - if the product has completed the ignition procedure (green LED on), press the key (briefly for 0.5 seconds) to change the power according to this diagram:
 - LOW flame power 1 and ventilation level 1
 - MEDIUM flame power 3 and ventilation level 3
 - HIGH flame power 5 and ventilation level 5

Every time the power is changed, a buzzer will indicate the selected power on the stove:

- 1 beep = LOW
- 3 beeps = MEDIUM
- 5 beeps = HIGH

If the product is running, switch it off by pressing the key for 3 seconds.



Attention! If the user erroneously presses the button for more than 10 seconds with the stove off, it will automatically place the stove in download mode to update the firmware (operation restricted to an authorised technician). This way, the stove remains on standby, with an intermittent buzzer, for a USB key containing the firmware update. If a USB key is not inserted, the stove exits this mode after 10 seconds.

17-MANUAL CONFIGURATION

If the remote Wi-Fi and temperature probe configurations do not work automatically, you must proceed with manual configuration.

MANUAL REMOTE WI-FI MODULE CONFIGURATION

From a mobile phone -> Wi-Fi settings menu, Wi-Fi is enabled from a mobile phone.

Search for “MCZ-RemoteService” from among the Wi-Fi networks available and connect to it (no password is required since it is an open network).

Once connected to the following network, open the phone's browser and enter the following address: 192.168.1.1.

A screen opens, displaying nearby Wi-Fi routers. Select the router providing internet connection and enter the respective password. From now on, if the router provides a stable internet connection, it is possible to control the stove remotely.

Note: when the remote Wi-Fi module is configured correctly and connected to a router, the “MCZRemote Service” network disappears from the list of available Wi-Fi networks.

MANUAL WI-FI TEMPERATURE PROBE CONFIGURATION

Once the 3 AA batteries are installed, the Wi-Fi temperature probe remains configurable for 8 minutes (ATTENTION! Only insert the batteries just before proceeding with configuration).

Insert the batteries and start the procedure.

From a mobile phone -> Wi-Fi settings menu, Wi-Fi is enabled from a mobile phone.

Search for “MCZ-Sensor” from among the Wi-Fi networks available and connect to it (no password is required since it is an open network).

Once connected to the following network, open the phone's browser and enter the following address: 192.168.1.1.

A window opens that displays the stoves that can be associated with the Wi-Fi probe. Select your stove and enter the Wi-Fi Home password (on the QR code label)

Once the Wi-Fi probe is connected, you can configure the stove to use the remote sensor; to do so, open the MCZ MAESTRO APP, connect to your previously configured stove, use the shortcut by clicking on the temperature indicator at the top right of the app screen and select the “Wi-Fi probe” as the temperature input.

Or from the setup menu -> configure ambient input and select the “Wi-Fi probe” temperature input.

Notes: when the Wi-Fi temperature sensor has been configured correctly and connected to your MCZ stove, the “MCZ-Sensor” network disappears from the list of Wi-Fi networks available.

18-APP FUNCTIONS

Once the devices are configured, the App will automatically try to connect to the last device used. If connection is successful, the App will display the "I/O" screen. It is possible to switch on and use all stove functions from here.

If it tries to connect to the last connected device and something goes wrong, the App will display the list of configured devices.

Click the device you want to connect to for connection.

When connected, the icon of a stove together with the name of the selected stove will appear.

It is now possible to access all stove functions.

I/O SCREEN



ON/OFF KEY

- START-UP
- SHUTDOWN



SWITCHING THE EQUIPMENT OFF

To switch the equipment off, press and hold the ON-OFF button on the remote control or on the APP. The acoustic beep confirms this phase has started.

Alternatively, switch it off from the emergency panel by following the instructions provided in the dedicated chapter

The equipment will start the shutdown process which involves consuming the residual pellets in the brazier, the latter being cleaned and the residual heat in the structure being dissipated.

During the residual heat dissipation phase, the fans operate at about 80% of their output and the speed cannot be varied. This is determined by the need for all the accumulated heat to be evacuated safely and quickly. The shutdown stage can last 15 - 30 minutes depending on the heat stored in the structure, determined by the duration and the operating speed of the product throughout the day.

When the internal temperature drops below the set thresholds, the fans for hot air and exhaust smoke extraction will automatically switch off.

18-APP FUNCTIONS

FAN SCREEN



AIR FAN

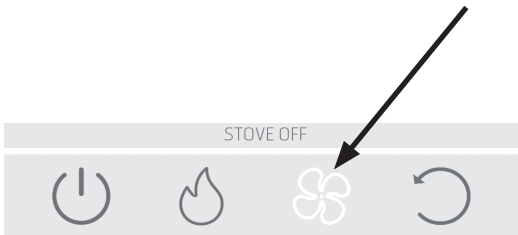

This screen manages the fan power of each single fan.

There are 5 power levels that can be set.

Each fan has the option of automatic operation and the option to switch off the fan

If the ventilation is set MANUALLY, the function which limits the maximum power of the stove according to the ventilation is enabled.

COMFORT AIR (3 FANS): maximum power level = total of the ventilation levels/2

AIR: maximum power level = twice the total of the levels of ventilation

Each fan is available with automatic function and NO AIR function to switch ventilation off, in the models where this is possible, to promote natural convection, or to run them noiselessly at minimum speed to assure heat emission of the structure.

The SILENT function allows the stove to operate at low power all night without room ventilation, in models where included, otherwise with very noiseless fan operation to assure emission of the structural heat.

19-SIDE DROP DOWN MENU

SET SCREEN

The menu can be selected on the top left of the three lines and includes SHORTCUTS (shortcut and / or quick settings)

- LANGUAGE
 - LIST OF DEVICES
 - CHRONOTHERMOSTAT
 - ECOSTOP
- SETTINGS
- SET FACTORY PARAMETERS
 - DATE AND TIME
 - BOARD INPUTS
 - CONFIGURE WIFI PROBE
 - BEEP ON / OFF
 - ACCESSORIES
 - FUNCTIONALITY
 - CHRONOTHERMOSTAT
 - ECOSTOP
 - SLEEP
 - SETTINGS
 - FEED SCREW ON
 - RECIPES
 - SUMMER/WINTER
 - PELLET SENSOR
 - BRAZIER CLEANING (AIR MATIC / HYDROMATIC)
 - SOFTWARE VERSION
 - TECHNICAL MENU
 - ABOUT

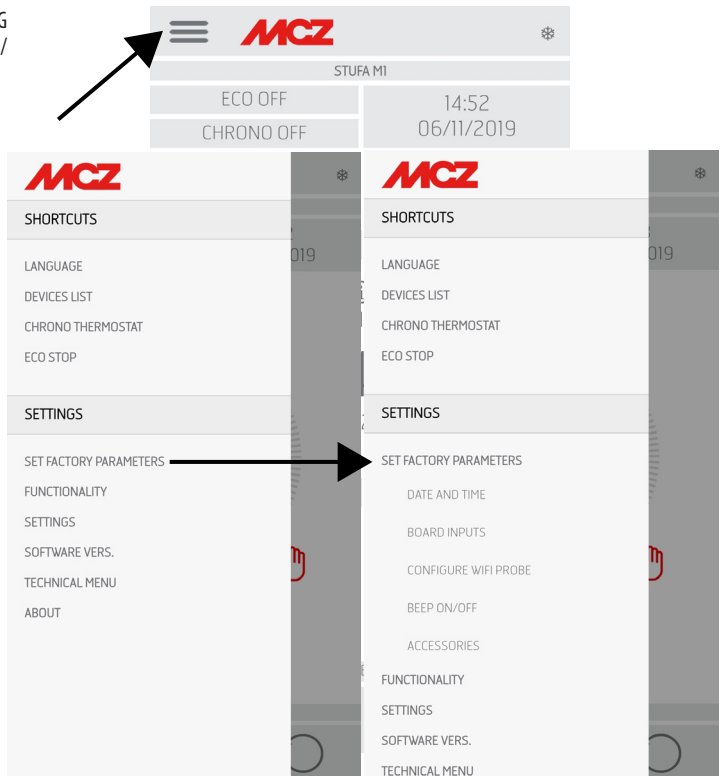

20-SHORTCUTS SETTINGS / RAPID SETTINGS

SHORTCUTS (shortcut and / or quick settings)

- LANGUAGE
- DEVICES LIST
- CHRONOTHERMOSTAT
- ECOSTOP

LANGUAGE SCREEN

Entering the side menu, select LANGUAGE and the system will display all the languages available. Select the desired language.

Press the SAVE button to confirm the chosen language.

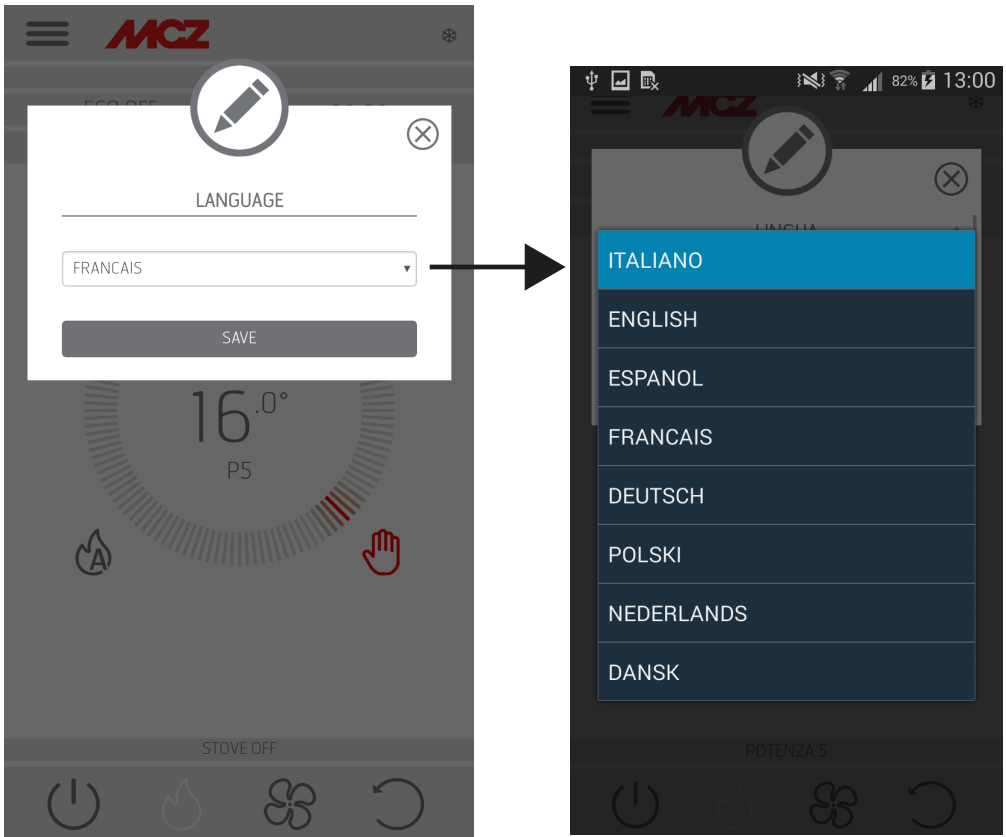

20-SHORTCUTS SETTINGS / RAPID SETTINGS

LIST OF DEVICES

This screen displays which devices have been configured. Only the device depicting the icon of a stove next to it can be selected. From the menu next to the configured device it is possible to access the MODIFY or DELETE function.

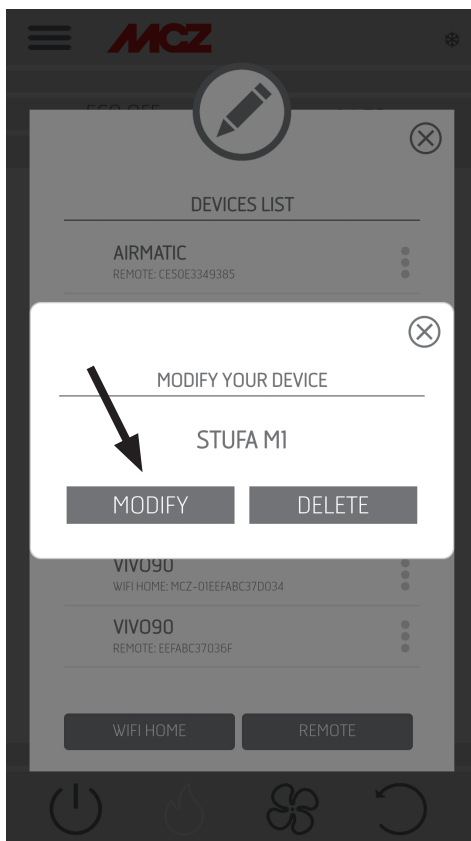
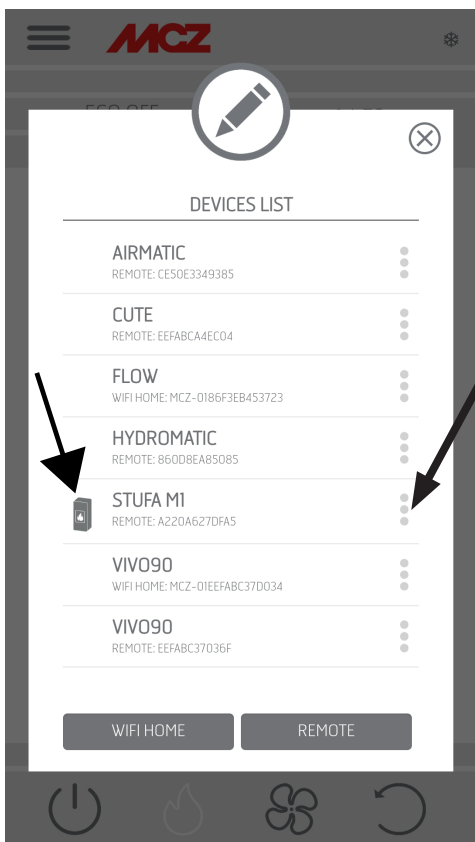

20-SHORTCUTS SETTINGS / RAPID SETTINGS

CHRONOTHERMOSTAT

Temperature selection option (T1-T2-T3)

Option to set the weekly programs.

Option to set different temperatures for different days of the week and different time bands.

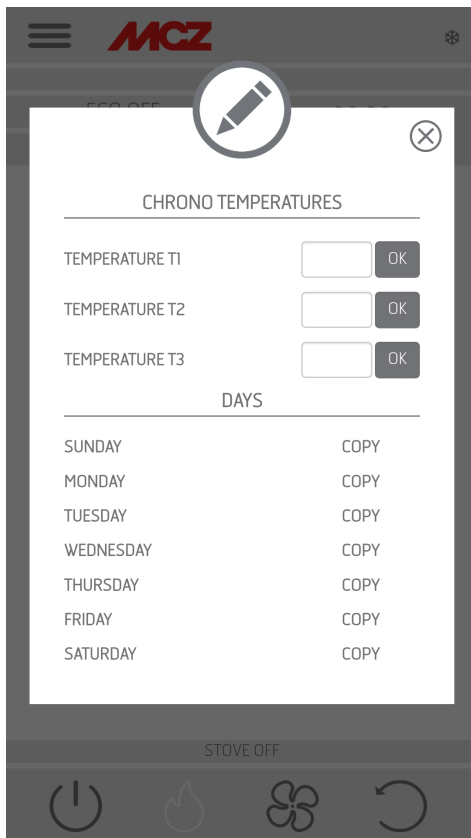

20-SHORTCUTS SETTINGS / RAPID SETTINGS

ECOSTOP

From the **ECO STOP** menu, it is possible to set and/or edit delayed activation (min) and Reignition hysteresis (C°).

ECO is an automatic mode with the only difference that if the set temperature is reached and remains so for the time (in minutes) that was selected from the delayed activation drop-down menu (value ranging between 5 and 30 minutes), the product switches off and remains in stand-by until the room temperature drops below the desired temperature (hysteresis frequency ranges between 2 and 5 minutes). The product then switches back on again.

If the room is not sufficiently insulated, flame modulation does not allow the set temperature to stay satisfied for the set time and the product will not switch off.

NOTE: It is recommended to use the ECO mode only in well-insulated rooms in order to prevent start-up and shutdown from occurring within short periods of time.

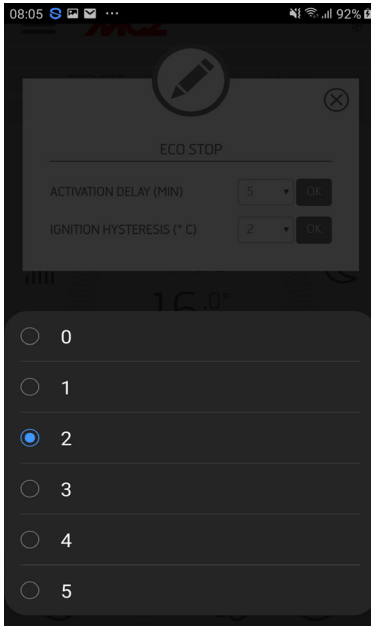
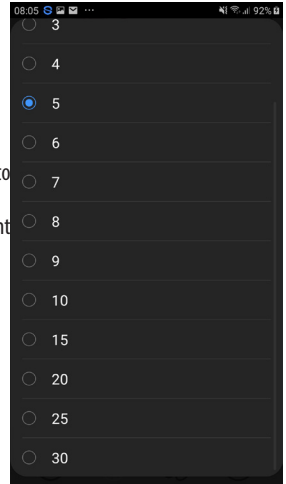

21-SET FACTORY PARAMETERS

SET FACTORY PARAMETERS

- DATE AND TIME
- BOARD INPUTS
- CONFIGURE WIFI PROBE
- BEEP ON / OFF
- ACCESSORIES

DATE AND TIME

Press the DATE AND TIME key to access the screen to edit data. After setting the data, press SAVE and exit the screen.

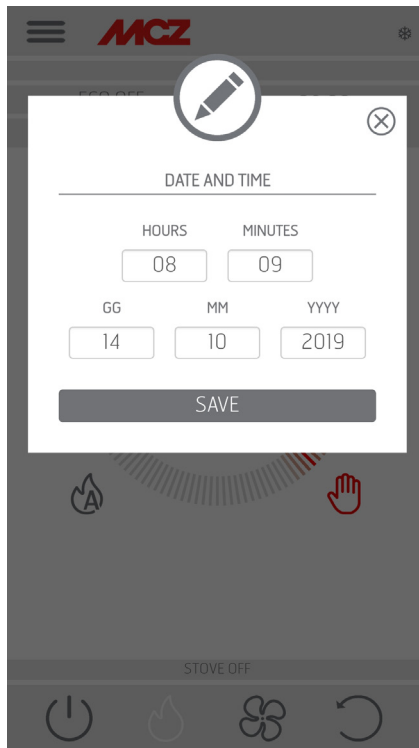

21-SET FACTORY PARAMETERS

BOARD INPUTS

Room input is used to set the Wi-Fi probe, thermostat or room probe. Click the drop-down menu to select the desired option.

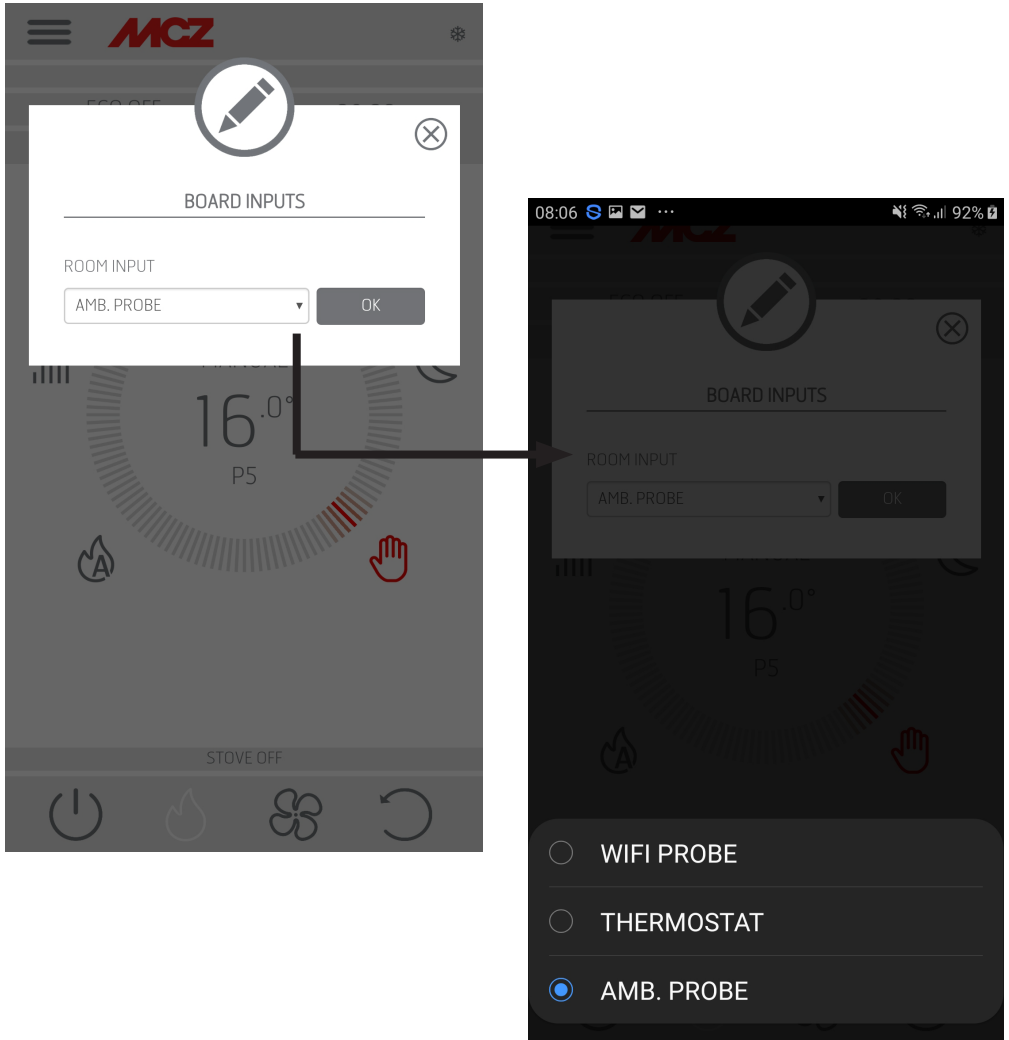

21-SET FACTORY PARAMETERS

CONFIGURE WIFI PROBE

This screen configures the frequency (in minutes) and shows the last connection made.

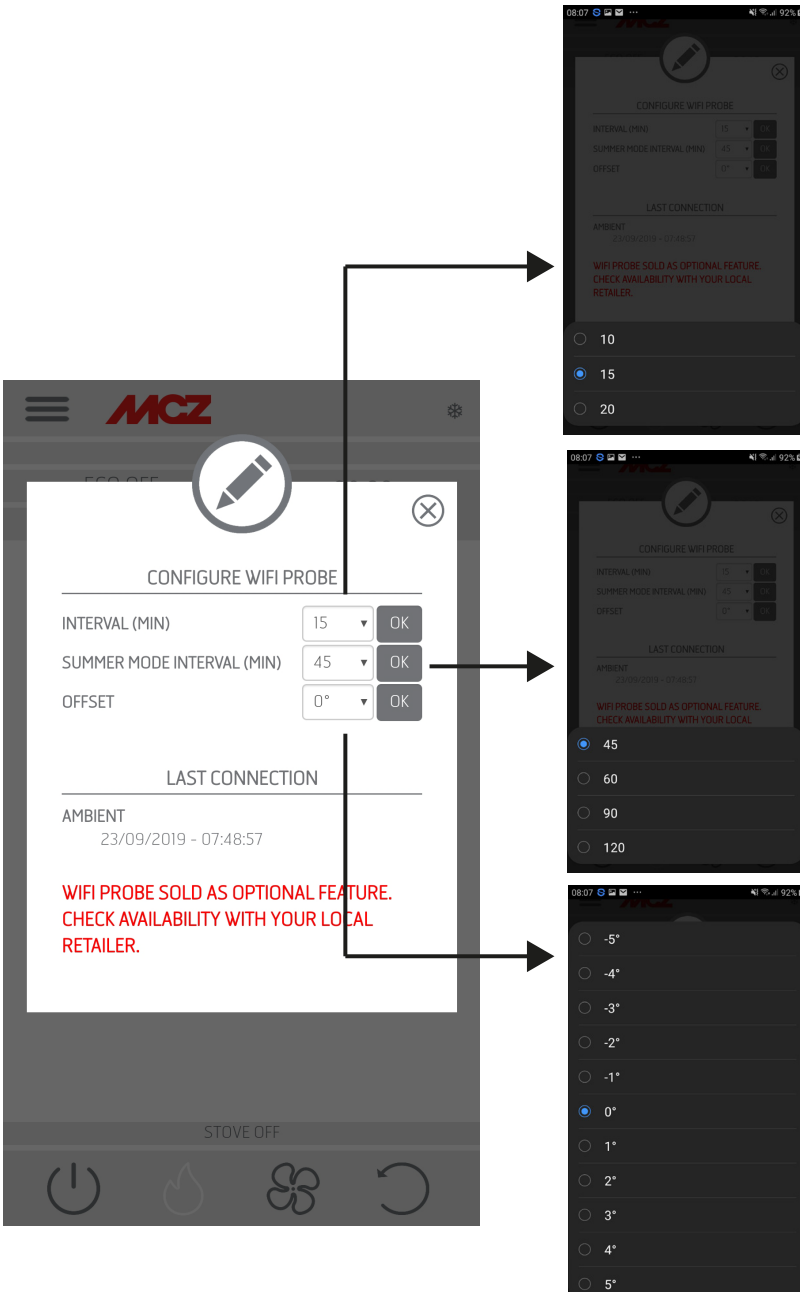

21-SET FACTORY PARAMETERS

BEEP ON / OFF

This function is used to enable/disable the tones.

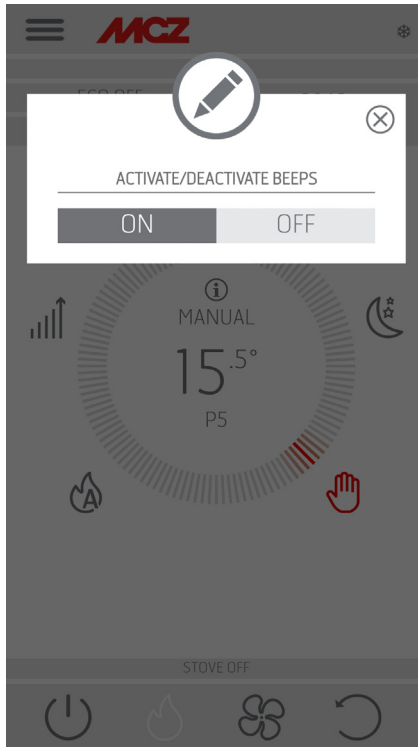

21-SET FACTORY PARAMETERS

ACCESSORIES

Entering the ACCESSORIES menu it is possible to CONFIGURE:

- REMOTE CONFIGURATION
- T PROBE CONFIGURATION

Refer to Chapter 3 (“Configure stove accessories”) for the mode.

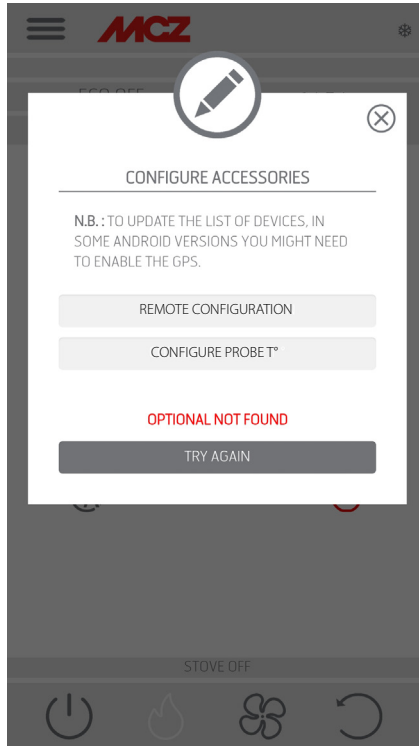

22-OPERATION MENU

FUNCTIONALITY

- CHRONOTHERMOSTAT
- ECO STOP
- SLEEP

CHRONOTHERMOSTAT

Temperature selection option (T1-T2-T3)

Option to set the weekly programs.

Option to set different temperatures for different days of the week and different time bands.

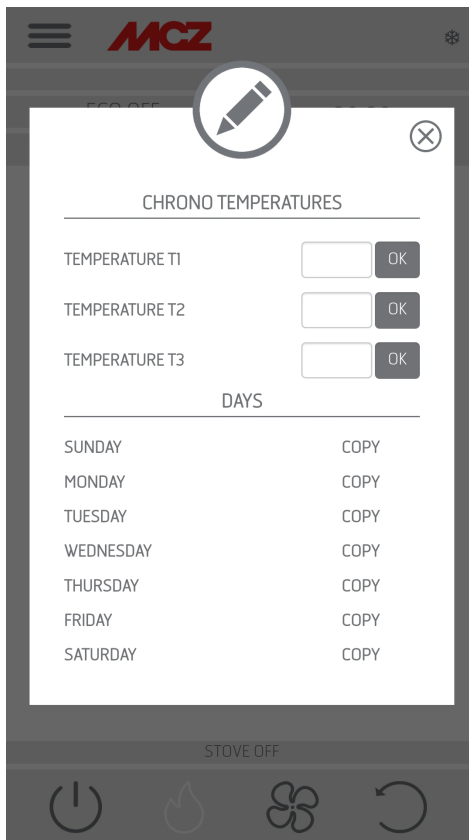

22-OPERATION MENU

ECOSTOP

From the **ECO STOP** menu, it is possible to set and/or edit delayed activation (min) and Reignition hysteresis (C°).

ECO is an automatic mode with the only difference that if the set temperature is reached and remains so for the time (in minutes) that was selected from the delayed activation drop-down menu (value ranging between 5 and 30 minutes), the product switches off and remains in stand-by until the room temperature drops below the desired temperature (hysteresis frequency ranges between 2 and 5 minutes). The product then switches back on again.

If the room is not sufficiently insulated, flame modulation does not allow the set temperature to stay satisfied for the set time and the product will not switch off.

NOTE: It is recommended to use the ECO mode only in well-insulated rooms in order to prevent start-up and shutdown from occurring within short periods of time.

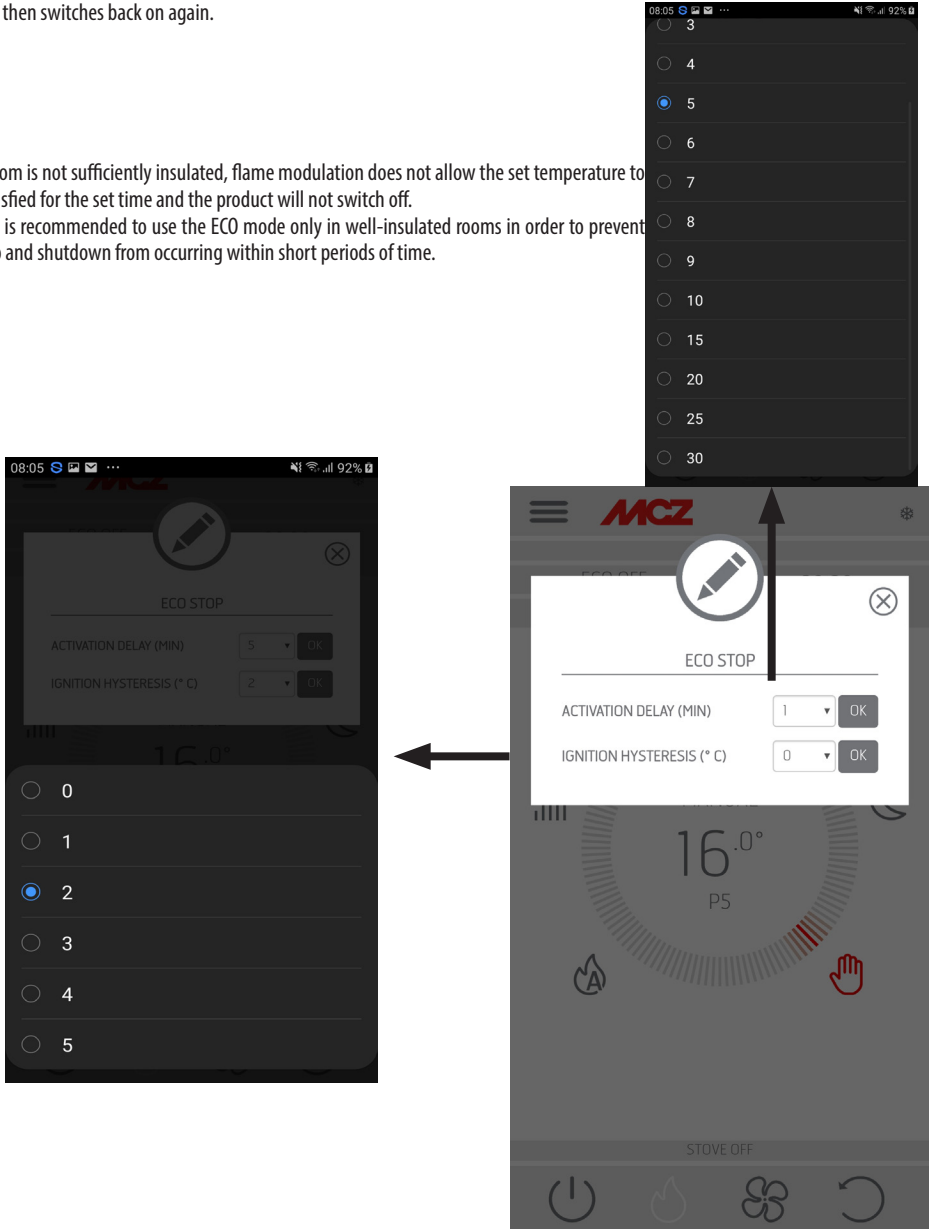

22-OPERATION MENU

SLEEP

Sleep mode allows to quickly set the time when the product must switch off. This function is only available in MAN and AUTO mode. To enable or disable the SLEEP function, touch the relative key.

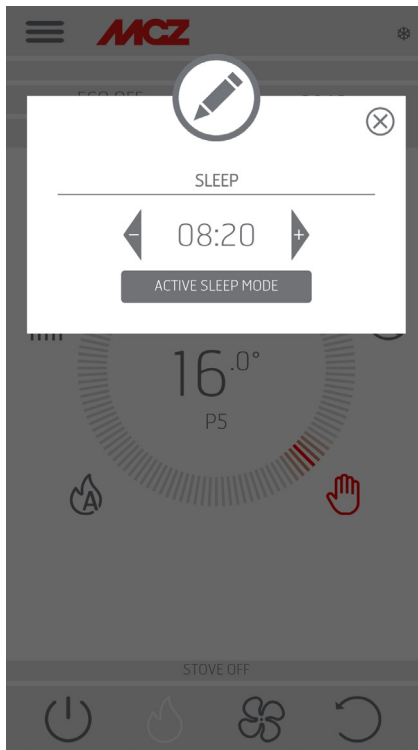

23-SETTINGS MENU

SETTINGS

- FEED SCREW ON
- RECIPES
- SUMMER/WINTER
- PELLET SENSOR
- BRAZIER CLEANING

FEED SCREW ON

This function, which can only be activated with the stove off, enables you to load pellets into the loading system (feed screw), and is used every time pellets in the hopper run out.

It is useful to prevent failed start-ups (alarm A01) due to the hopper being empty.

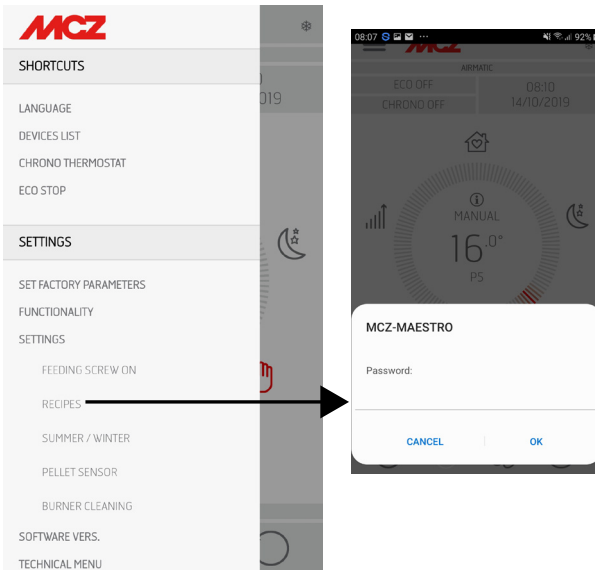
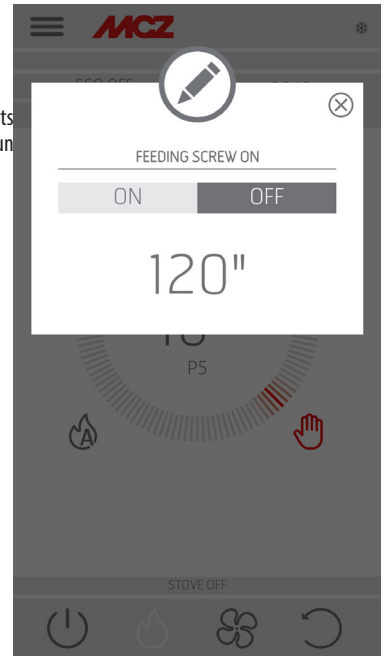

RECIPES

To enable this function, enter the SETTINGS menu and select RECIPE. The POP-UP appears prompting the password, enter 1234. You may now edit the two functions: AIR RECIPE and PELLET RECIPE.

23-SETTINGS MENU

Modifying the pellet recipe and air recipe

This function is for adapting the stove to the type of pellet in use. In fact, since there are many types of pellets on the market, operation of the

stove varies significantly depending on the good or poor quality of the fuel.

The amount of pellets in the brazier can be increased or reduced:

- If the pellets tend to jam in the brazier due to an excess of fuel
- If the flame is increasingly higher even at low power values
- If the flame is always low



ATTENTION! When you access the pellet recipe menu, a POP-UP appears prompting a password. Enter "1234"-

To edit the **AIR recipe**, select one of the values available.

The available values are:

-- 2 = - 10%

- 1 = - 5%

0 = (default value)

1 = + 5%

2 = + 10%

This function is used to adjust combustion air if the flame is too high or too low.

To edit the **PELLET** recipe, select one of the values available.

The available values are:

- 3 = Reduction of pellet loading by 20% at all power values

- 2 = Reduction of pellet loading by 13% at all power values

- 1 = Reduction of pellet loading by 6% at all power values

0 = no change

1 = Increase of pellet loading by 3% at all power values

2 = Increase of pellet loading by 6% at all power values

3 = Increase of pellet loading by 10% at all power values



Attention! It is preferable that this mode ("Pellet recipe"/ "Adaptive mode") be activated under the supervision of a qualified technician.

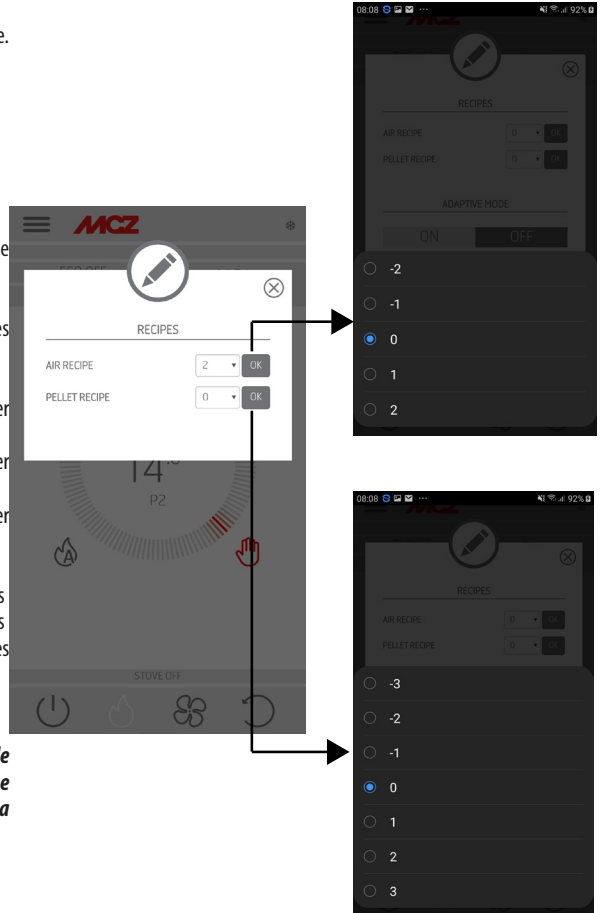

23-SETTINGS MENU

SUMMER/WINTER

Option to select the operating season.

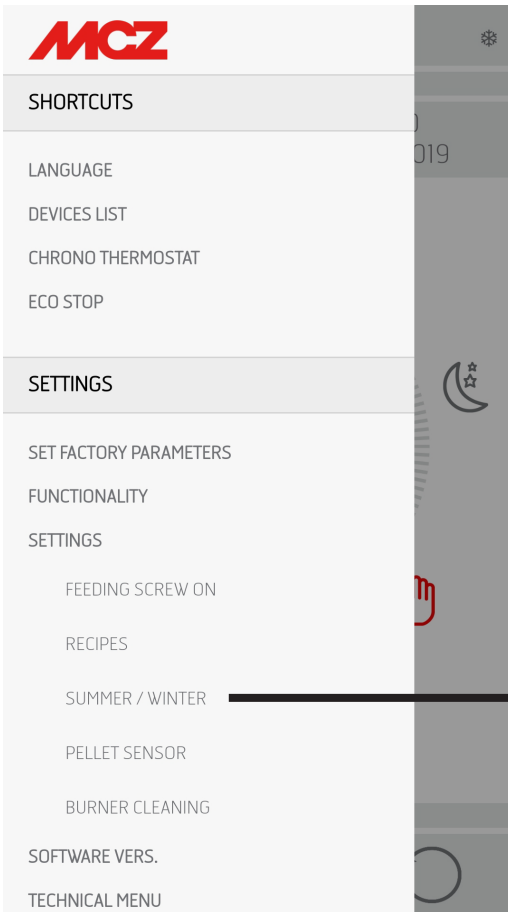

23-SETTINGS MENU

PELLET SENSOR

The pellet sensor is used to measure the level of pellets in the hopper. It can be activated from the side menu, SETTINGS after having assembled the sensor on the hopper and carried out the appropriate connection in the card (see next page).

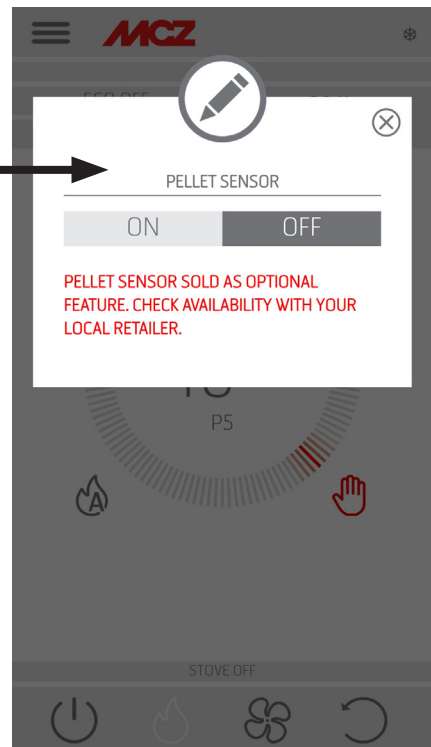
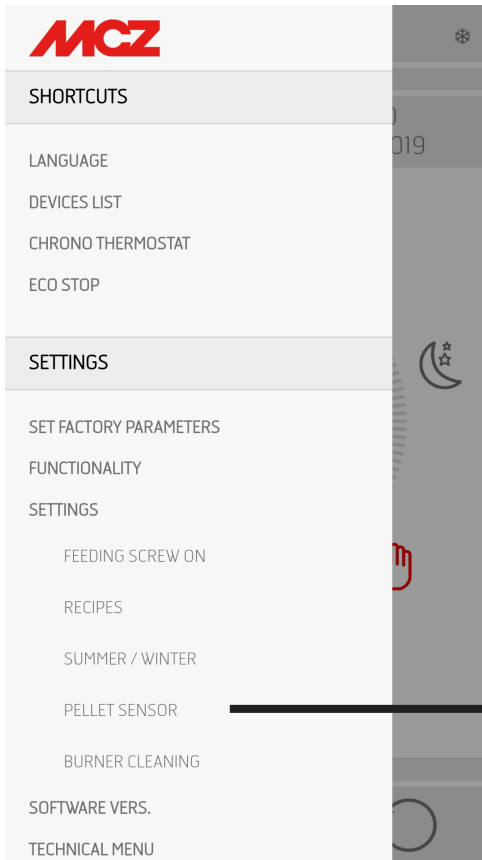

23-SETTINGS MENU

ASSEMBLING PELLET LEVEL SENSOR

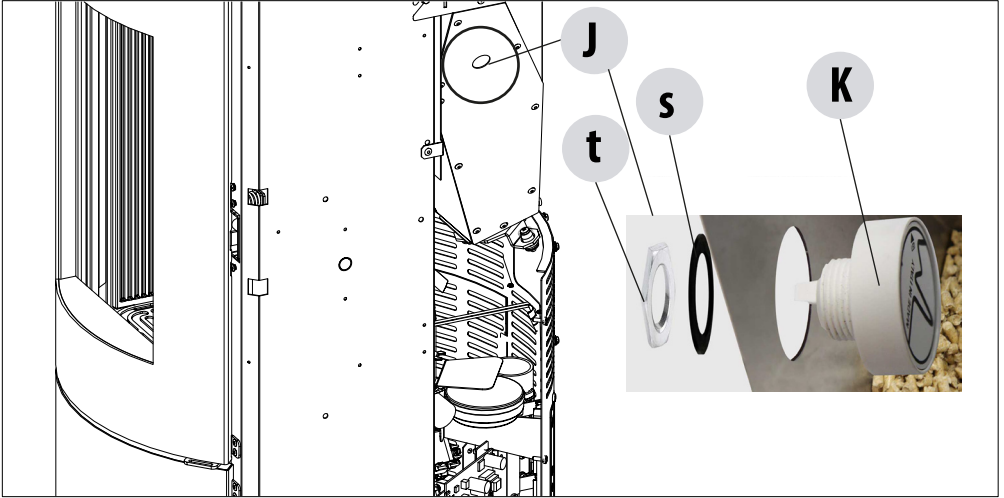

The pellet sensor is a low fuel indicator that warns the user that the pellets are finishing.

With the hopper empty, lift the pellet loading cover and manually remove the cap "J" fitted inside, then insert the pellet level sensor "K" from inside the hopper.

The sensor is locked to the tank by externally mounting the seal "s" and firmly securing it with the ring nut "t".

The sensor must then be connected to position 16 on the circuit board with the cable supplied.

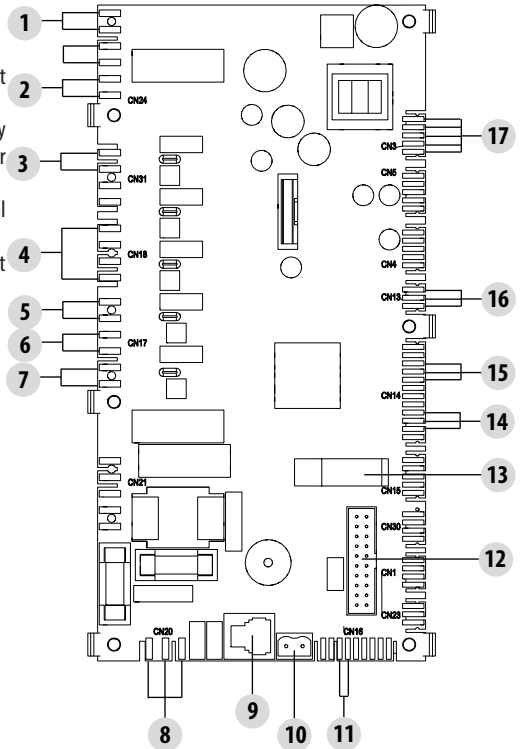

23-SETTINGS MENU

BRAZIER CLEANING

Only for "MATIC" products with automatic brazier cleaning system.
Press "ENABLE" to set a complete cleaning cycle for the product.

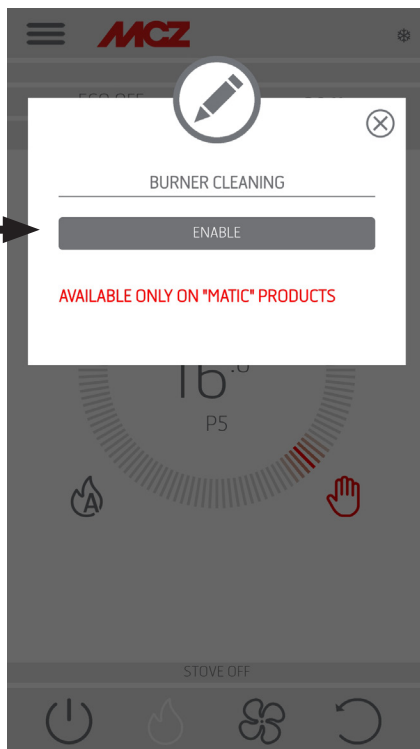
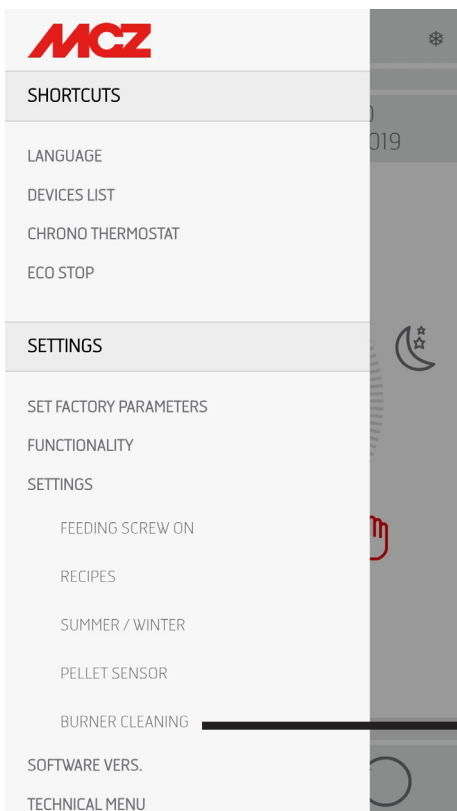

24-SOFTWARE VERSION

SOFTWARE VERSION

The SOFTWARE VERSION option is found in the SETTINGS menu. Through this item it is possible to know all the stove information e.g. Database and app version

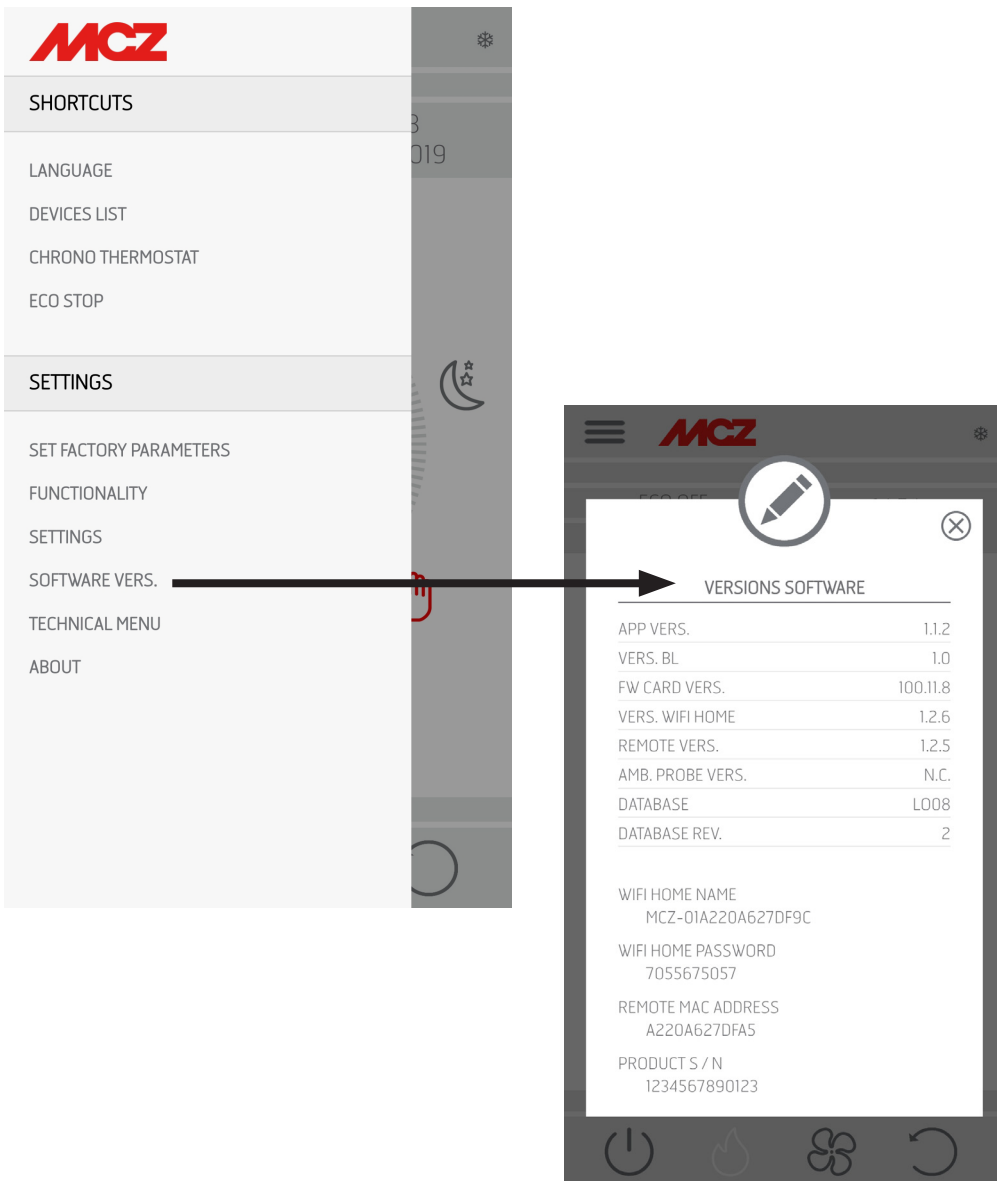

25-TECHNICAL MENU

TECHNICAL MENU

To enter the TECHNICAL MENU, select the three dashes at the top, scroll to the end of the drop-down menu and select the item. To enter the functions it is necessary to enter a Password (available for authorised technicians) and press OK.

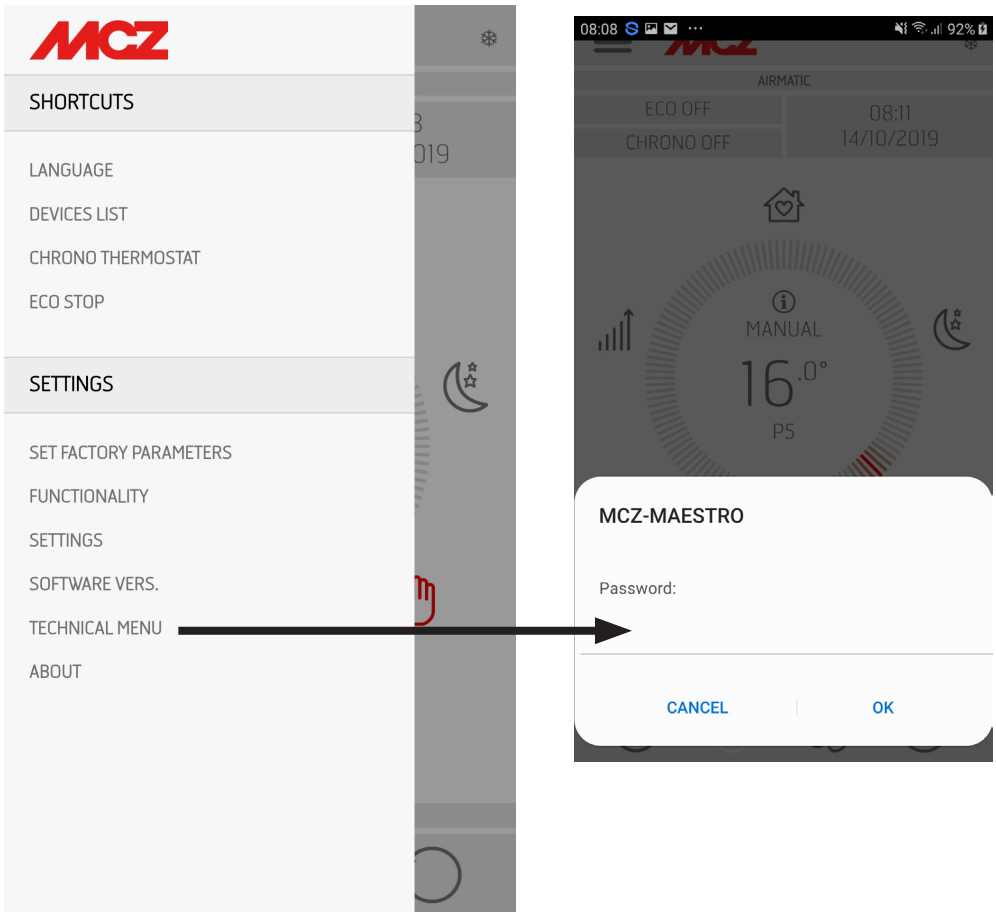

25-TECHNICAL MENU

The main functions that can be changed and/or controlled from the technical menu are:



PARAMETERS	⏪	
ACTIVE ON / OFF	⏪	•
SYSTEM T°	⏪	•
DIAGNOSTICS	⏪	•
SELECT DATABASE	⏪	•
FACTORY DATA RESET	⏪	•
SERVICE HOURS RESET	⏪	•
LAST ALARMS	⏪	•
WORKING HOURS	⏪	•



26-INFO MENU

ABOUT

The INFO menu provides certain information regarding the stove's status

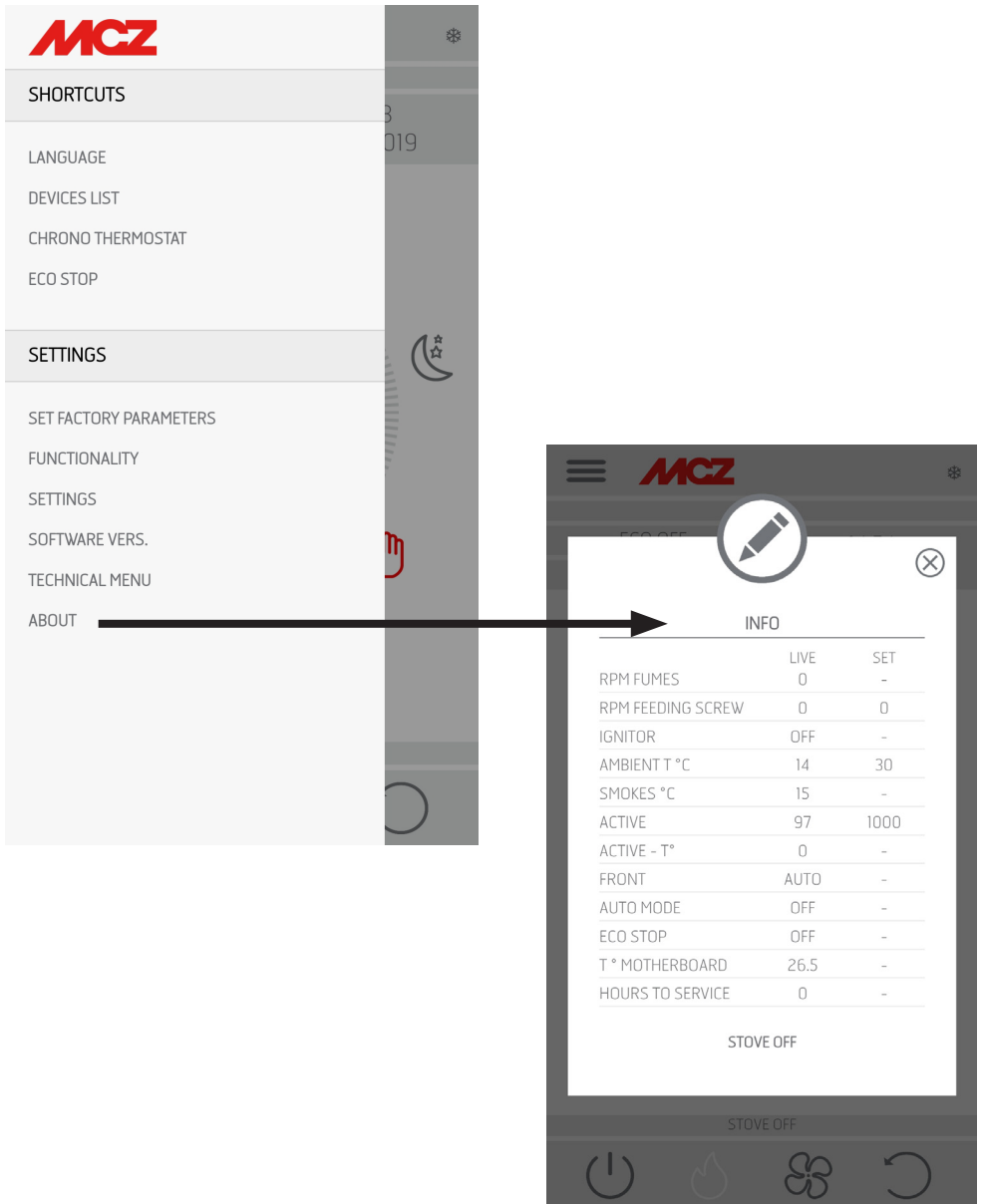

27-SAFETY DEVICES

SAFETY DEVICES

The product is fitted with the following safety devices.

SMOKE TEMPERATURE PROBE

It detects the temperature of the smoke, thereby enabling start-up or stopping the product when the temperature drops below the preset value.

PELLET HOPPER TEMPERATURE PROBE

If the temperature exceeds the preset safety value, it immediately stops the product, which must cool down before the stove is restarted.

ELECTRICAL SAFETY

The product is protected against power surges by a general fuse located in the control panel on the back. Other fuses that protect the circuit boards are located on the latter.

SMOKE FAN BREAKAGE

If the fan stops, the circuit board promptly blocks the supply of pellets and the alarm is displayed.

GEAR MOTOR BREAKAGE

If the gear motor stops, the product switches off and the relative alarm is signalled.

TEMPORARY POWER CUT

If a power cut occurs during operation, the product automatically sets itself in cooling mode when the power is restored and then it restarts.

FAILED START-UP

If no flame lights during start-up, the product will go into alarm conditions.



IT IS FORBIDDEN TO TAMPER WITH THE SAFETY DEVICES

It is possible to relight the product and therefore restore the automatic operation of the probe only after having eliminated the cause of the intervention of the safety system. This manual will help you understand which anomaly has occurred, and explain how to intervene according to the alarm message displayed on the appliance.

28-ALARMS

ALARM ALERTS

In the event an operating anomaly occurs the stove starts switching off due to the alarm. The type of alarm appears on the App. The app signals the active alarm codes while a red LED lights up on the stove panel.

The following table describes the possible alarms indicated by the stove, associated to the respective code that appears on the emergency panel and helpful tips to solve the problem.

MESSAGE ON DISPLAY	TYPE OF PROBLEM	SOLUTION
A01	The flame does not light	Check the level of pellets in the hopper. Check that the brazier is correctly positioned in its seat and has no deposits or unburnt material. Make sure the glow plug warms up. Thoroughly empty and clean the brazier before restarting.
A02	The fire goes out abnormally.	Check the level of pellets in the hopper. Check that the brazier rests correctly in its seat and has no visible deposits of unburned pellets.
A03	The temperature of the pellet hopper exceeds the required safety threshold. The structure overheats due to reduced heat dissipation.	The structure is too hot because the product has been used for too long at the maximum power or there is poor ventilation. When the product is sufficiently cold, press button B on the control panel or OFF on the remote control to cancel alarm A03. Once the alarm is cancelled, the product can be switched on normally.
A04	The temperature of the exhaust smoke has exceeded certain preset safety limits.	The stove switches off automatically. Let the stove cool down for a few minutes and then switch it on again. Check the smoke expulsion and verify the type of pellet used according to the instructions found in Chap. 2 of this manual.
A05	Chimney flue clogged - wind.	Check the smoke duct and make sure the door is closed.
	The smoke extractor fails to guarantee sufficient primary air, required for correct combustion.	Draught difficulties or brazier clogged. Check whether the brazier is clogged and clean it, if necessary. Check and if necessary clean the smoke duct and the air inlet.
A08	Abnormal operation of smoke fan	Check cleanliness of the smoke fan compartment and check if dirt is blocking it. If this is not enough, the smoke fan is faulty. Contact an authorised service centre to have it replaced.
A09	The smoke probe is faulty and does not detect the exhaust smoke temperature properly.	Contact an authorised service centre to have the component replaced.
A11	Pellet supply fault	Contact an authorised service centre to have the component replaced.

28-ALARMS

A12	Faulty gear motor driving sensor (PWM)	Contact an authorised service centre.
A13	Electronic control unit overheating	The structure is too hot because the product has been used for too long at the maximum power or there is poor ventilation. When the stove is sufficiently cold, press button B on the control panel or OFF on the remote control to cancel alarm A13. Once the alarm is cancelled, the product can be switched on normally.
A14	Faulty air flow rate sensor	This alarm blocks the stove and can be reset from the App. If the sensor is faulty, the alarm appears once again. Contact an authorised service centre to have the component replaced.
A17	Blocked feed screw due to clogged pellets or a foreign body	The feed screw is not unblocked even after the feed screw unblocking procedure indicated by the software has been carried out (rotating the gear motor in both directions). Try to remove the pellet and/or foreign body with an extractor or call an authorised service centre to perform this operation.
A21 TRIPPED SAFETY DEVICES	Open stove door	Close the door
	Open fuel loading hatch	Close the hatch. Lower the fuel level in the hopper.
	Air pressure switch	Draught difficulties or brazier clogged. Check whether the brazier is clogged by deposits and clean it, if necessary. Check and if necessary clean the smoke duct and air inlet.
A22	Room probe anomaly	Contact an authorised service centre to have the component replaced.
POP-UP	Disconnected Wi-Fi probe	Make sure the device has charged batteries Replace the batteries and restart the device's connection procedure
POP-UP	Alarms	From the App, it is possible to receive a message regarding the alarms that cannot be reset from the App, such as A01, A02, A03, A05, A21, but which can only be reset from the stove's panel. After resetting the alarm from the panel, reset the message from the App.

28-ALARMS

Exiting the alarm conditions

Follow the procedure described below to restore normal stove operation after an alarm has been triggered:

- Cancel alarms A01, A02, A03, A05, A21 only from the panel on the stove.
- Cancel the other alarms from the App.

Mechanical stove block

The following conditions may cause the mechanical stove block:

- Structure overheating ("A03")
- Smoke overheating ("A04")
- During stove operation air has entered the combustion chamber or there is an obstruction in the flue ("A05")

Only alarm **A21** emits an intermittent buzz as long as the alarm is active. In this situation, the automatic shut-down sequence is activated. When this sequence is initiated, any attempt to restart the system will be ineffective. The display signals the cause of the blockage.

SOLUTIONS:

If "**A03**" appears: the structure is too hot because the product has been used for too long at the maximum power or there is poor ventilation. When the stove cools down sufficiently, clear alarm A03 on the stove panel. Once the alarm is cancelled, the product can be switched on normally.

If "**A04**" appears: The stove switches off automatically. Let the stove cool down for a few minutes and then switch it on again. Check the smoke expulsion and verify the type of pellet used according to the instructions found in the specific chapter of the manual.

If "**A05**" appears: the door has been left open for too long or a significant amount of air has entered (e.g. missing smoke fan inspection cap). If these causes are excluded, check and if necessary clean the smoke duct and flue (it is recommended for this operation to be carried out by an MCZ qualified technician).

The product can be switched on again only after having eliminated the cause permanently.

EXTERNAL THERMOSTAT CONNECTION

To connect the external thermostat, disconnect the room probe from the terminal in position 4 of the circuit board.

28-ALARMS

In the event that alarm A21 is triggered often, please note that:

A21 TRIPPED SAFETY DE- VICES	Open stove door	Close the door
	Open fuel loading hatch	Close the hatch. Lower the fuel level in the hopper.
	Air pressure switch	Draught difficulties or brazier clogged. Check whether the brazier is clogged by deposits and clean it, if necessary. Check and if necessary clean the smoke duct and air inlet.

you must check some points to verify the cause of the problem and possibly act on some adjustments and/or safety devices to restore the correct operation of the product.

However please note that all adjustments and alterations affecting the operational safety devices, must only be performed if THE PRODUCT IS INSTALLED IN COMPLIANCE WITH THE STANDARDS AND LAWS IN FORCE AND IF IT IS SERVICED PROPERLY BY AUTHORISED AND SPECIALISED PERSONNEL. Alterations performed randomly, to ensure operation of the product even in non-compliant conditions, can cause serious damage to property and injuries to people.

Attention!

The adjustments must only be carried out by authorised and qualified personnel under their responsibility and by checking the conformity of the installation beforehand. The manufacturer declines all liability for damage to property or injuries to people in the event of altering the safety devices.

All liability for improper use of the product is entirely borne by the user and relieves the Manufacturer from any civil and criminal liability.

Series of stoves equipped with a pressure switch installed on the hopper with the sampling point positioned on the bottom, to the right of the gear motor. This system protects the whole system ensuring tightness of the stove throughout its duration.

It is important to understand that the pressure switch can be triggered with each significant drop in negative pressure and may be due to:

- Flue clogging.
- The presence of a foreign body in the flue (birds, nests, clogged grates, etc.).
- Wind coming through the flue because it is unprotected or the installation was wall-mounted or required no flue.
- Cold air draught down the flue.
- A damaged pressure switch.
- Blocked membrane inside the pressure switch because soot or pellet dust filtrated.
- The pellet hopper is open or ajar for more than 60 seconds (60 seconds is the estimated time to reload the hopper).
- Pellet trapped between the hopper cover and the hopper, which prevents the gasket to seal.
- Broken/worn hopper cover gasket.
- The gasket between the feed screw and the boiler is damaged or positioned incorrectly.
- Fire door is open or the gasket is worn.
- Clogged lateral smoke exchangers.
- Inspection caps with gaskets installed incorrectly after maintenance.
- Feed screw clogged by compressed pellets at the top.
- The installation is compliant and the flue/smoke fitting does not generate obvious obstructions which can stop the release of smoke, such as: long horizontal sections (over 3 metres), uninsulated smoke ducts, "wall-mounted" smoke exhaust without proper terminals (installation regulated and permitted in France only [ZONE 3])
- Internal air extraction or recirculation systems (e.g. VMC systems) that generate internal negative pressure exceeding those required by law (not exceeding 4 Pa)
- Installed without combustion air ducting, it is crucial to check that there is an efficient air inlet dedicated to the stove, according to the specifications referred to in chapter 2 of this manual.

28-ALARMS

The circuit board has also been equipped with an automatic device with a timer and contactors which increase the RPM of the smoke extractor so as to restore the negative pressure inside the hopper and therefore the pressure switch, if the cover is opened for top-up or if there is an immediate or occasional pressure drop such as gusts of wind outside. If the pressure drop lasts for more than 60 seconds, the product is set in an alarm status (A05 or A18)

Remembering that the draught recommended for the products to work properly is 10 Pa at maximum capacity and 5 Pa at minimum (according to the technical data sheet found in the user and maintenance manual), adjustments may be required in worse draught conditions (also due to the position of the flue in areas that are particularly subject to adverse weather such as prevailing winds, snow, northern exposure, etc.) so as to always guarantee the required negative pressure inside the hopper.

To compensate for the lack of internal negative pressure simply adjust the speed (RPM) of the smoke extractor so as to guarantee the minimum tabular values.

If the negative internal pressure values are noted to be lower than those indicated, this can also be due to the internal gaskets not being sealed properly or by the product being worn over time.

OPERATING INSTRUCTIONS ON NEGATIVE PRESSURE INSPECTIONS AND POSSIBLE VARIATIONS OF THE RPM

Connect a pressure gauge to the pressure outlet on the hopper:

- In the case of products with a specific pressure outlet in the hopper, access the sampling point and connect the pressure gauge
- In the case of products without a dedicated pressure outlet, disconnect the tube of the pressure switch from the pressure outlet on the hopper, add a "Tee" on the tube to intercept the circuit, connecting the gauge and reconnect the tube to the pressure outlet on the hopper.

Possible adjustments of the combustion and consequently of the negative pressure inside the hopper can be implemented in two ways:

A) Change the RPM value of the smoke extractor in the SETTINGS MENU

- The available values are from -3 to +3 which, as a percentage, correspond to:
- RPM: -10% +10% in Active System products
- RPM: -30% +50% in NON Active System products
- The percentage variation affects all power values (1 to 5) proportionally and as a percentage. The percentage variation does not affect intermediate operating stages such as SWITCH ON, FIRE ON or SWITCH OFF
- As the RPM increase, suction also increases and consequently the internal negative pressure, thereby compensating the phenomena that trigger the alarm.

B) Adjusting the RPM of the gear motor manually in the TECHNICAL PARAMETERS MENU

- The pressure switch has a calibration of 10/20 Pa which means that it disarms when the negative pressure inside the hopper drops below 10 Pa and requires more than 20 Pa negative pressure inside the hopper for it to rearm
- The negative pressure value at the minimum power must always be higher than 10 Pa while also maintaining a reasonable margin that can be used over time due to the gaskets being worn or something similar (at least 12/13 Pa)
- The negative pressure at maximum power must always be above 20 so that the pressure switch can rearm when the pressure switch rearming automated device is activated. The pressure switch rearming procedure (such as after opening the cover to top-up the hopper), requires the electronics to push the RPM of the smoke extraction fan up to POWER 5 (P5) for a few moments. At P5, therefore, the negative pressure inside the hopper must always be > 20 Pa (recommended 22/23 Pa to preserve the margin).
- **N.B. = The TECHNICAL PARAMETERS menus are password-protected to prevent the user from accessing them inadvertently**



Attention! The factory setting on the product is designed to obtain the certified technical data. In the event of data discrepancy (as for the pellet recipe), the settings may be modified as set out above.

The adjustments must only be carried out by authorised and qualified personnel under their responsibility and by checking the conformity of the installation beforehand.

28-ALARMS

NEGATIVE PRESSURE INSIDE THE HOPPER WITH FACTORY-SET PARAMETERS AND A DRAUGHT OF 5 Pa (MINIMUM RECOMMENDED)

POWER	P1	P2	P3	P4	P5	VALUES
6 kW	13.7/14.2 Pa	15.1/15.6 Pa	17.1/17.5 Pa	19.1/19.5 Pa	22.0/22.2 Pa	Draught
	95°C	110°C	125°C	141°C	165°C	Smoke temperature
8 kW	13.8/14.3 Pa	15.6/16.1 Pa	17.8/18.0 Pa	21.7/22.2 Pa	26.1/26.6 Pa	Draught
	104°C	119°C	145°C	148°C	184°C	Smoke temperature
10 kW	15.9/16.3 Pa	20.4/20.9 Pa	25.8/26.3 Pa	31.8/32.3 Pa	36.5/37.0 Pa	Draught
	108°C	°C	150°C	°C	230°C	Smoke temperature
12 kW	16.5/17.3 Pa	20.4/20.9 Pa	25.8/26.3 Pa	31.8/32.3 Pa	36.5/37.1 Pa	Draught
	118°C	127°C	155°C	172°C	195°C	Smoke temperature
14 kW	17.6/18.0 Pa	19.8/20.4 Pa	23.1/23.7 Pa	28.9/29.6 Pa	37.8/38.2 Pa	Draught
	118°C	131°C	161°C	187°C	210°C	Smoke temperature

PLEASE NOTE The indicated negative pressure readings may differ by ± 1 Pa based on flue gas temperature. Likewise, flue gas temperature may differ by ± 10 °C based on fuel quality or appliance cleanliness.

Changing the smoke fan speed

In order to further improve combustion in critical conditions, you can change the percentage of the parameters for the minimum amount of incoming combustion air. These changes can be performed upwards in the event of serious difficulties in evacuating smoke and/or air intake or downwards in the event of excessive draught of the flue.

Refer to AIR RECIPE modification instructions.

AVAILABLE VALUES

-2 -10%

-1 -5%

0 0% (default value)

+1 +5%

+2 +10%

29-RECOMMENDATIONS FOR SAFE USE



ONLY CORRECT INSTALLATION AND APPROPRIATE MAINTENANCE AND CLEANING OF THE APPLIANCE CAN GUARANTEE CORRECT OPERATION AND SAFE USE OF THE PRODUCT.

We would like to inform you that we are aware of cases of malfunctioning of domestic pellet-fuelled heating products, mainly due to incorrect installation and use, as well as inadequate maintenance.

We would like to assure you that all of our products are extremely safe and certified according to European standards of reference. The ignition system has been tested with the utmost attention to enhance ignition efficiency and to prevent any type of problem, even in the worst operating conditions. In any case, like for any other pellet-fuelled product, our appliances must be installed correctly and undergo regular periodical cleaning and maintenance to guarantee safe operation. Our studies show us that malfunctioning is mainly due to the combination of part or all of the following factors:

- Brazier holes obstructed or brazier deformed, due to lack of maintenance and conditions which can cause delayed ignitions, generating an anomalous production of unburned gases.
- Insufficient combustion air due to a reduced or clogged air inlet duct.
- Use of smoke ducts nonconforming to regulatory installation requirements, failing to guarantee an adequate draught.
- Partially clogged chimney, due to lack of maintenance, reducing the draught and making ignition difficult.
- End chimney pot nonconforming to the indications of the instruction manual, and therefore not suitable to prevent potential inverse draught.
- This factor is crucial when the product is installed in especially windy areas, such as coastal regions.

The combination of one or more of these factors could generate important malfunctioning conditions.

To keep this from occurring, it is fundamental to guarantee that the product is installed in compliance with standards in force.

Furthermore it is of the utmost importance to respect the following simple rules:

- Every time the brazier is removed for cleaning, it must always be put back properly in the work position before using the product, completely removing any residual filth left on the support base.
- Pellets must never be loaded in the brazier manually, either before ignition or during operation.
- The accumulation of unburned pellets ensuing a failed ignition must be removed before repeating ignition. Also check that they are fed correctly and that the combustion air inlet/smoke outlet are regular.
- If ignition fails repeatedly, immediately suspend use of the product and contact a qualified technician to check its operation.

Compliance with these indications is absolutely sufficient to guarantee proper operation and to avoid any type of problems with the product.

If the above-mentioned precautions are not taken, and during ignition the brazier is overloaded with pellets thus generating anomalous smoke in the combustion chamber, carefully follow the indications below:

- Do not disconnect electrical power to the product for any reason whatsoever: this would stop the smoke extractor, releasing smoke into the environment.
- Take the precaution of opening the windows to ventilate the installation room from any smoke in the environment (the chimney might not work properly).
- Do not open the fire door: this would compromise regular operation of the smoke extraction system to the chimney.
- Just switch the stove off by acting on the on-off button on the control panel (not the rear power supply socket button!) and move away until smoke has been completely extracted.
- Before attempting re-ignition, clean the brazier and its air passage holes completely of all deposits and unburned pellets. Put the brazier back in place, removing any residue from its support base. If ignition fails repeatedly, immediately suspend use of the product and contact a qualified technician to check its operation and the chimney.

30-CLEANING

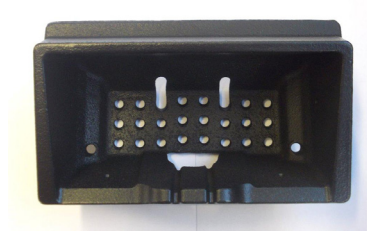

EXAMPLE OF A CLEAN BRAZIER



EXAMPLE OF A DIRTY BRAZIER

Only by properly servicing and cleaning the product is it possible to ensure its safety and correct operation.



ATTENTION!

All the cleaning operations of all parts must be performed with the product completely cold and the plug disconnected.

Disconnect the product from the 230V power supply before performing any maintenance operation.

The product requires little maintenance if used with certified good quality pellets.

DAILY OR WEEKLY CLEANING PERFORMED BY THE USER

Brazier cleaning

Before ignition, always clean the brazier "T" and remove any ash or incrustation from it that might obstruct the air flow holes, paying attention to hot ash. In the case of ignition failure, or if fuel in the hopper runs out, unburned pellets may accumulate in the brazier. Always empty the residue in the brazier before each start-up. **Only if ash is completely cold** may a vacuum cleaner be used to remove it. In this case, use a suitable vacuum cleaner to remove small sized particles.

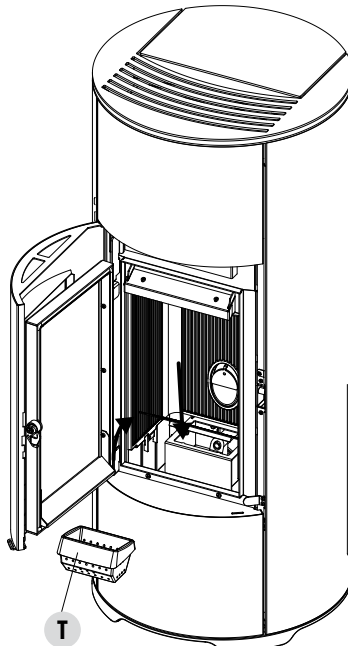

30-CLEANING



REMEMBER THAT ONLY A CORRECTLY POSITIONED AND CLEAN BRAZIER CAN GUARANTEE SAFE IGNITION AND OPTIMAL OPERATION OF YOUR PELLET PRODUCT. IN CASE OF FAILED IGNITION AND AFTER ANY OTHER LOCK STATE OF THE PRODUCT, IT IS ESSENTIAL TO EMPTY THE BRAZIER BEFORE EVERY RESTART

For the brazier to be cleaned properly, remove it from its housing completely and thoroughly clean all the holes and the grate on the bottom. If good quality pellets are used, you will normally only need to use a brush to restore the optimal operating conditions of the component.

Cleaning the ash box

To clean the ash box, lift the grid "g" simply by turning it until it rests against the stove firebox. Wipe away any residual ash before lowering the grid "g". Furthermore the stove is equipped with a large ash drawer "Z". To empty it, you must open the decorative door and lower the closing door "V" by turning the handle. The quality of the pellets used and user experience will determine the required cleaning frequency.

However, it is recommended not to exceed 2 or 3 days.

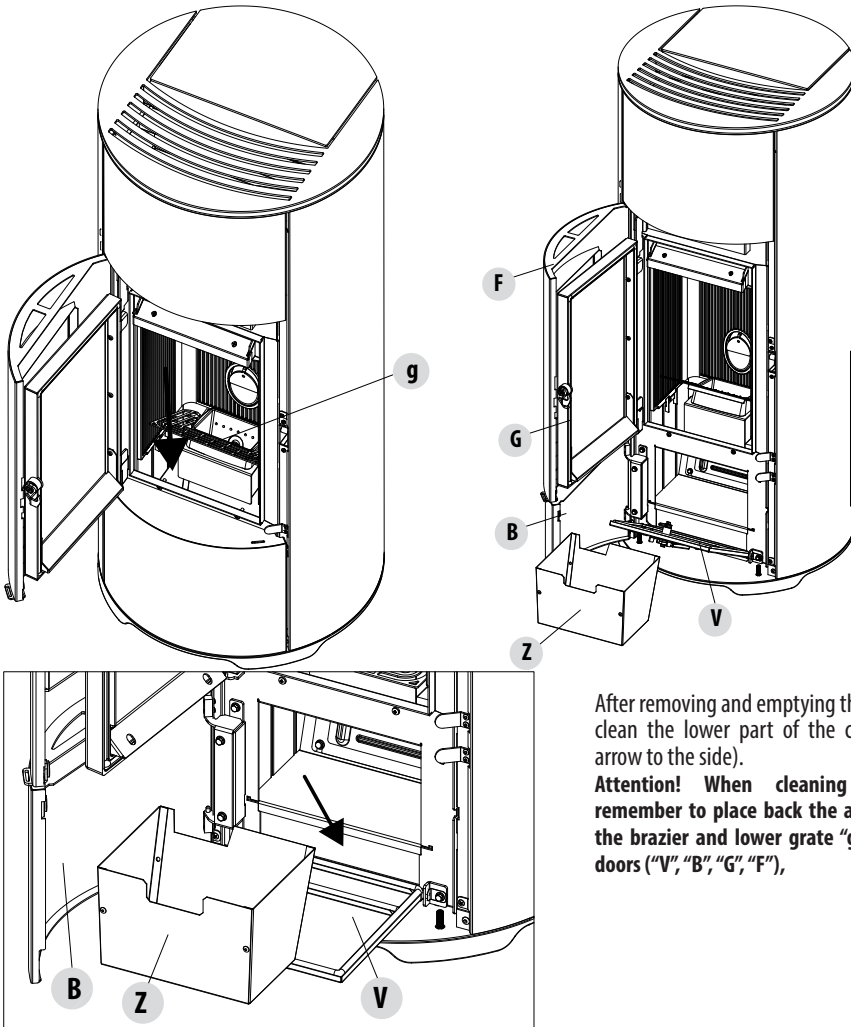

After removing and emptying the ash pan "Z" also clean the lower part of the compartment (see arrow to the side).

Attention! When cleaning is completed, remember to place back the ash pan "Z", insert the brazier and lower grate "g". Reclose all the doors ("V", "B", "G", "F"),

30-CLEANING

CLEANING THE GLASS

It is recommended to clean the ceramic glass with a dry brush, or if it is very dirty, spray a little specific detergent and clean with a cloth.



ATTENTION!

Do not use abrasive products and do not spray the glass cleaning product on the painted parts and on the door gaskets (ceramic fibre cord).

CLEANING THE AIR FILTER

A wire mesh air filter is found at the back of the stove, whose purpose is to prevent dirt entering the motor body and the internal sensor. It is recommended to check that the filter is clean every 15/20 days. If needed remove fluff or the material that has deposited on it.

Inspection and cleaning are required more frequently if there are pets in the house.

Simply remove the filter to clean. To clean it use a brush or a damp cloth or compressed air. Set it back in place by simply pressing it (interlocks).

The filter is made of metallic mesh and is soft and flexible to the touch therefore, when cleaning, be careful not to crush or damage it. In the event of breakage it must be replaced.



ATTENTION!

Never let the stove work without the air filter fitted. MCZ cannot be held liable for any damage caused to the internal components if this requirement is not complied with.

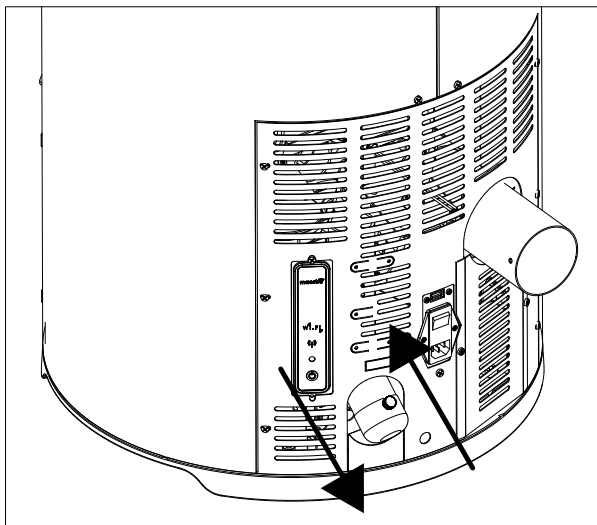

30-CLEANING

PERIODIC CLEANING PERFORMED BY A QUALIFIED TECHNICIAN CLEANING THE HEAT EXCHANGER AND THE LOWER COMPARTMENT

Half-way through the winter season, **but especially at the end**, the compartment through which the exhaust smoke passes will need to be cleaned. This cleaning process is mandatory in order to facilitate the general removal of all combustion residue, before it becomes very difficult to remove it due to moisture compacting it over time.



ATTENTION:

Cleaning is mandatory to be performed at the end of the season by an authorised and skilled technician so that even the seals can be replaced.

CLEANING THE LOWER COMPARTMENT

To clear the lower compartment of ashes, you must open the decorative door "F", the lower panel "B", and the door "V" by turning the designated closure. Now loosen the four screws "y", remove the plate "n" and the gasket "o". Use the nozzle of a vacuum cleaner to remove any ash and soot that may have built up in the lower exchanger (smoke extractor) indicated by the arrow.

Before putting the cap "n" back, it is recommended to change the gasket "o".

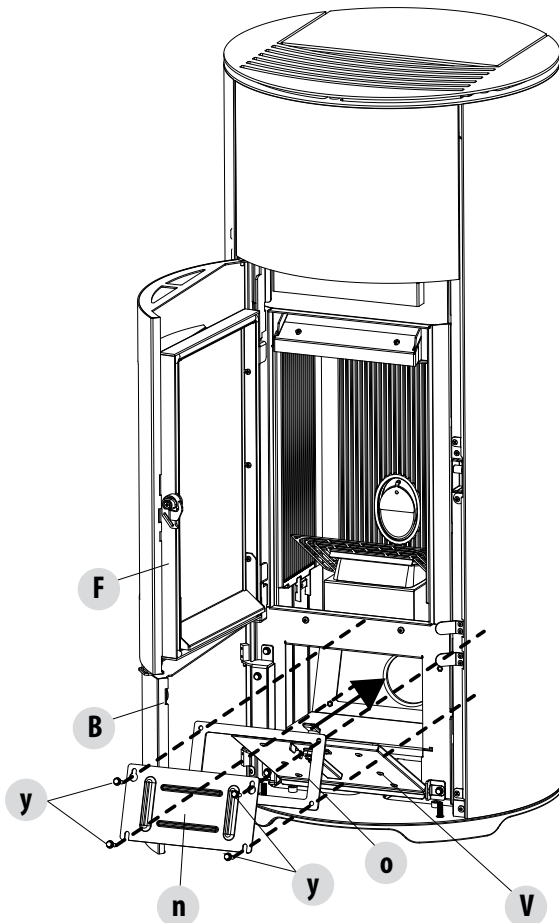

30-CLEANING

CLEANING THE EXCHANGER

CLEANING THE UPPER COMPARTMENT

Clean the upper exchanger when the stove is cold and without the cladding in question. After removing the cap to clean the lower compartment "n" (see previous paragraph), use a 1 metre long flexible brush to scrape the walls of the firebox (see arrow) to make the ash fall into the lower compartment.

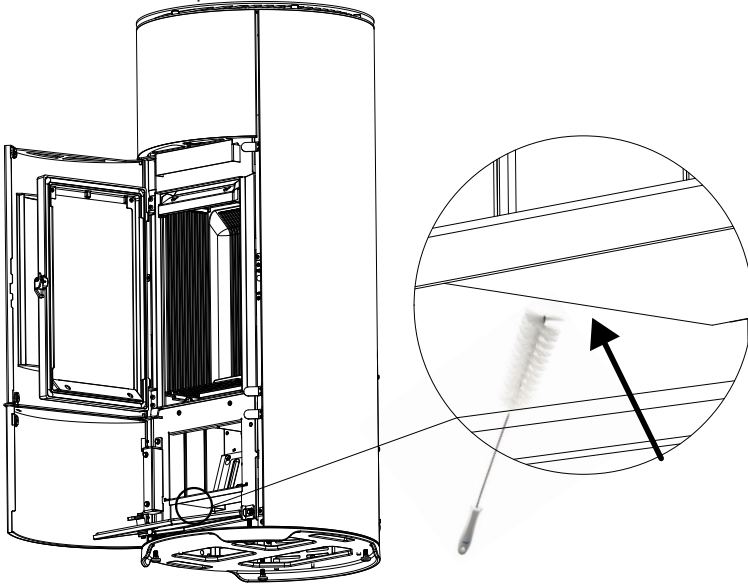

Then remove the upper calorite plate "H"; to do this open the firebox door, hold the top of the calorite plate "H" and lift it upwards, tilt it to the right or to the left in order to release it from the supports and remove it.

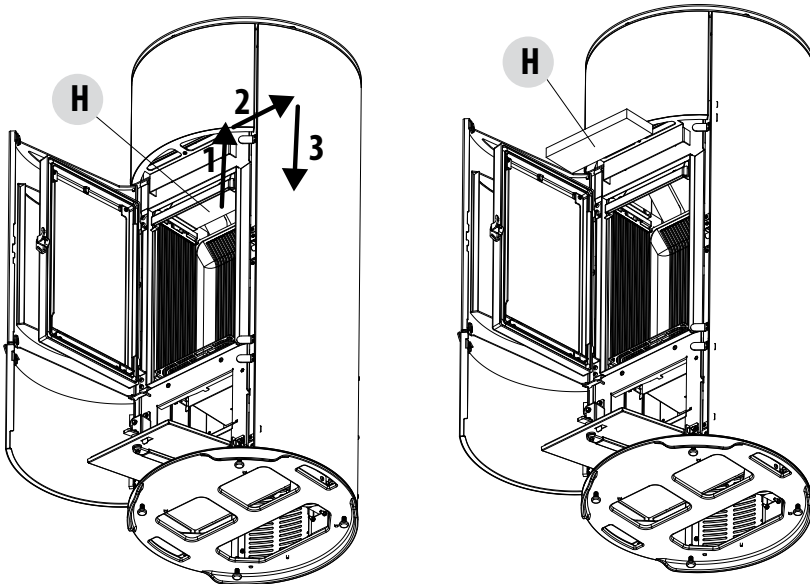

30-CLEANING

Use a flexible brush to scrape the walls of the firebox (see arrow - respectively to the right and to the left of the firebox) to make the ash fall into the lower compartment.

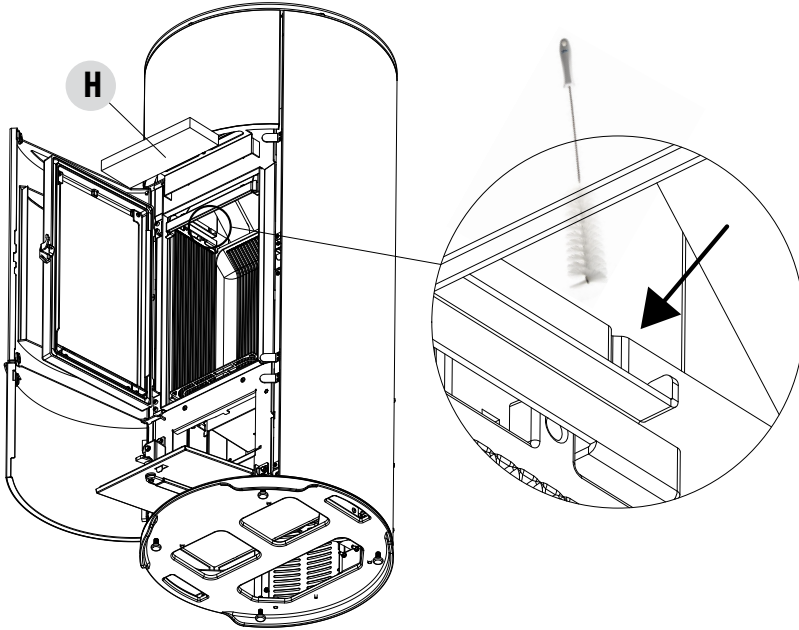

Use a vacuum cleaner nozzle to vacuum up any remaining ash and dust on the exchanger (see arrow).

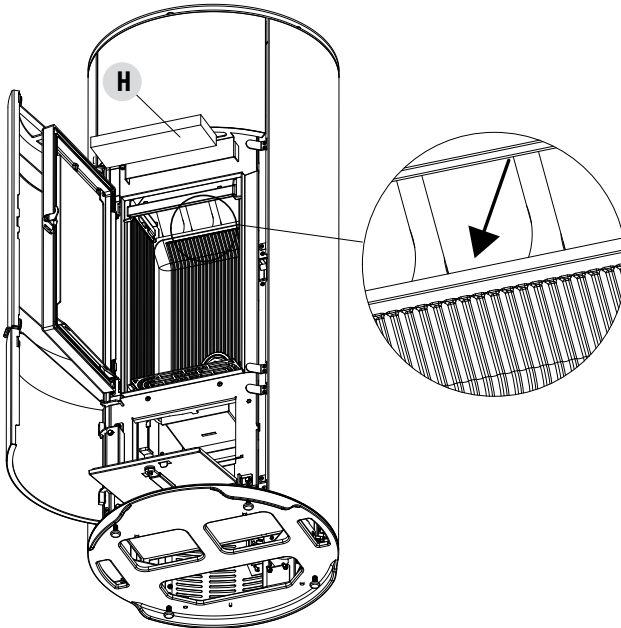

30-CLEANING

Even in the upper part, under the cover (top), use the nozzle of a vacuum cleaner to remove any dust that may have built up.

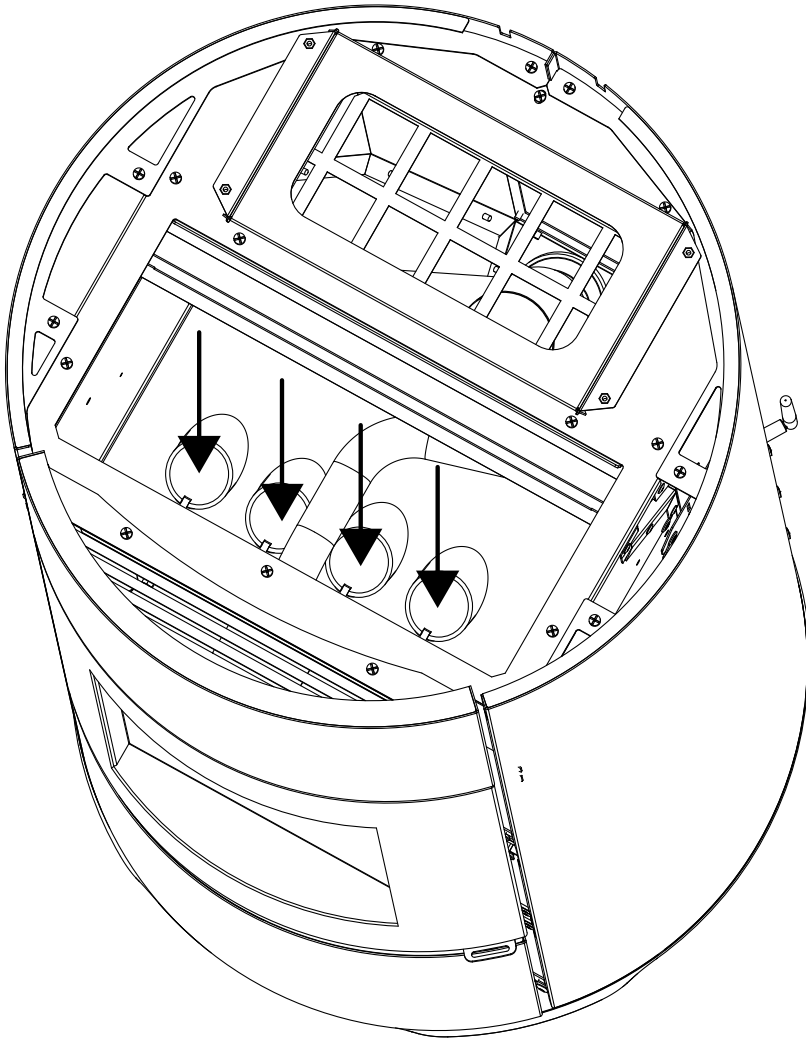

Then thoroughly clean the lower exchanger, replace any gaskets if needed, and reassemble.

30-CLEANING

CLEANING THE SMOKE EXHAUST SYSTEM AND GENERAL CHECKS

Clean the smoke outlet system, especially around any "T" fittings, bends and any horizontal sections of the smoke duct. For information on periodically cleaning the flue, contact a skilled chimney sweep.

Check the seal of the ceramic fibre gaskets on the door of the stove. If necessary, order new replacement gaskets from the retailer or contact an authorised service centre to carry out the operation.



ATTENTION:

The frequency with which the smoke outlet system is cleaned depends on the use of the boiler and the type of installation.

We recommend relying on an authorised service centre for end-of-season cleaning and maintenance, as they will carry out all of the previously mentioned work and inspect the stove components.

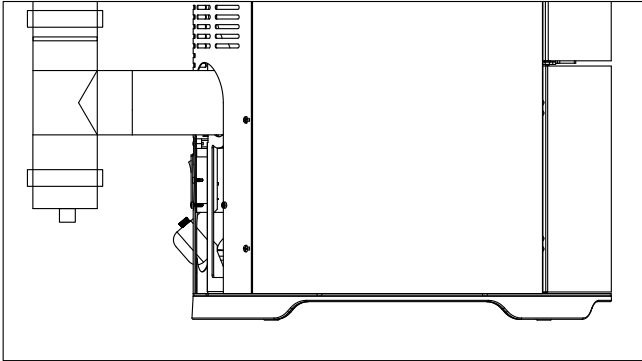

PERIODICAL CHECK OF THE DOOR CLOSURE

Make sure the door closure ensures a correct sealing action (with the "paper sheet" test) and that when the door is closed, the closing block (X in the figure) does not protrude from the sheet metal to which it is secured. For some products it will be necessary to disassemble the cladding to be able to assess the anomalous protrusion of the block when the door is closed.

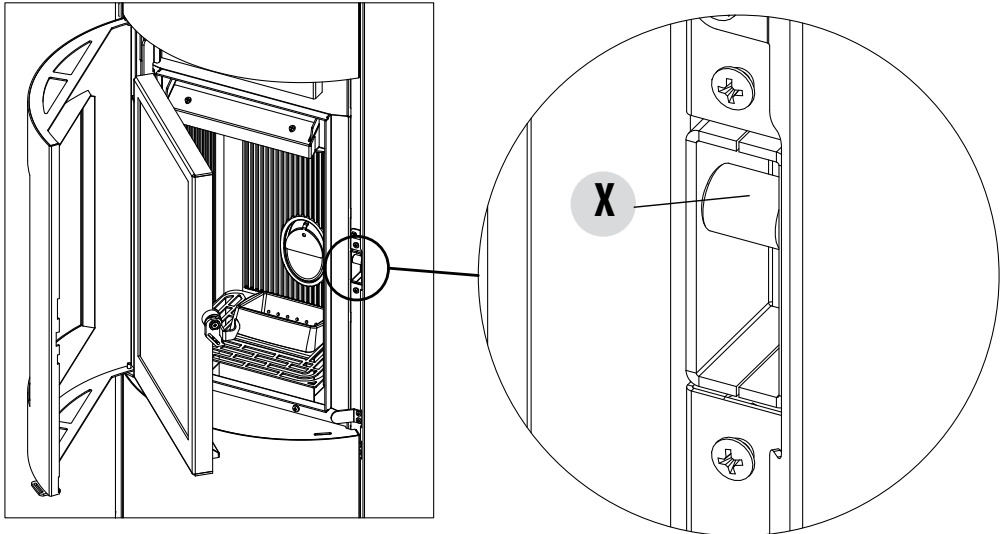

30-CLEANING

SHUTDOWN (end of season)

At the end of each season, before switching the product off, it is recommended to remove all the pellets from the hopper with a vacuum cleaner with a long pipe.

We recommend removing the unused pellet from the tank because it can retain moisture. Disconnect any combustion air ducting that can lead moisture inside the combustion chamber but, above all, ask the specialised technician to refresh the paint inside the combustion chamber with the special silicone spray paints (available at any store or CAT) during the necessary annual end of season scheduled maintenance operations. This way the paint will protect the inner parts of the combustion chamber, blocking any type of oxidative process.

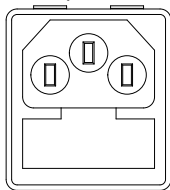

When not in use the appliance must be disconnected from the mains power supply. It is recommended to remove the power cable for additional safety, especially in the presence of children.

The service fuse may have to be replaced if the control panel display does not switch on when the product is switched on again by pressing the main switch on its side.

There is a fusebox on the side of the product, near the power socket. Open the fusebox cover with a screwdriver and replace the fuses if necessary (3.15 A delayed) - seek assistance from an authorised and qualified technician.

CHECKING THE INTERNAL COMPONENTS



ATTENTION!

The internal electromechanical components must only be checked by qualified personnel whose technical expertise includes combustion and electricity.

We recommend that an annual maintenance service is carried out (with a scheduled service contract). This service is essentially a visual and functional inspection of the internal components. The following is a summary of the checks and/or maintenance that are essential for the correct operation of the product.

	PARTS/INTERVAL	1 DAY	2-3 DAYS	7 DAYS	15/20 DAYS	1 YEAR
UNDER THE USER'S RESPONSIBILITY	Brazier	•				
	Ash compartment		•			
	Ash pan*			•		
	Glass		•			
BY THE QUALIFIED TECHNICIAN	Upper exchanger					•
	Lower exchanger					•
	Smoke duct					•
	Gaskets					•
	Door closure operation					•

* Emptying of the ash pan depends on various factors (pellet type, stove power, stove use, type of installation...) the exact emptying time will be suggested by experience.

31-TROUBLESHOOTING



ATTENTION!

All repairs must only be carried out by a specialised technician, with the product switched off and the plug disconnected.

ANOMALY	POSSIBLE CAUSES	SOLUTIONS
The pellets are not fed into the combustion chamber.	The pellet hopper is empty.	Fill the hopper with pellets.
	Sawdust has blocked the feed screw.	Empty the hopper and remove the sawdust from the feed screw by hand.
	Faulty gear motor.	Replace the gear motor.
	Faulty circuit board.	Replace the circuit board.
The fire goes out or the boiler stops automatically.	The pellet hopper is empty.	Fill the hopper with pellets.
	The pellets are not fed.	See the previous anomaly.
	The pellet temperature safety probe has been triggered.	Let the product cool down, restore the thermostat until the lockout is off and switch the appliance back on. If the problem persists contact Technical Assistance.
	Chrono active.	Check if the chrono setting is active.
	The door is not closed properly or the gaskets are worn.	Close the door and replace the gaskets with original ones.
	Unsuitable pellets.	Change the type of pellets with those recommended by the manufacturer.
	Low pellet supply.	Check the flow of fuel following the instructions in the manual.
	The combustion chamber is dirty.	Clean the combustion chamber, following the instructions in the manual.
	Clogged outlet.	Clean the smoke duct.
	Faulty smoke extraction motor.	Check the motor and replace it, if necessary.

31-TROUBLESHOOTING

ANOMALY	POSSIBLE CAUSES	SOLUTIONS
The product works for a few minutes and then switches off.	Start-up phase is not completed.	Repeat start-up.
	Temporary power cut.	Switch it back on.
	Clogged smoke duct.	Clean smoke duct.
	Faulty or malfunctioning temperature probes.	Check and replace the probes.
Pellets accumulate in the brazier, the glass of the door gets dirty and the flame is weak.	Insufficient combustion air.	Make sure that the air inlet in the room is fitted and clear. Clean the brazier and check that all the holes are clear. Perform a general cleaning of the combustion chamber and the smoke duct. Check the condition of the door gaskets.
	Damp or unsuitable pellets.	Change the type of pellets.
	Faulty smoke extractor motor.	Check the motor and replace it, if necessary.
The smoke extractor motor does not work.	No electrical supply to the stove.	Check the mains voltage and the protection fuse.
	The motor is faulty.	Check the motor and capacitor and replace them, if necessary.
	Defective circuit board.	Replace the circuit board.
	The control panel is broken.	Replace the control panel.
The convection air fan never stops.	Thermal probe defective or faulty.	Check the probe and replace it, if necessary.
	Fan faulty.	Wait a few minutes and check motor operation, replace it if necessary.
	The product has not reached the shutdown temperature yet.	Wait.

31-TROUBLESHOOTING

ANOMALY	POSSIBLE CAUSES	SOLUTIONS
The air fan does not switch on.	The product has not reached the temperature.	Wait.
The remote control does not work.	The remote control battery is flat.	Replace the battery.
	Remote control faulty.	Replace the remote control.
The product always runs at maximum power when in automatic mode.	The room thermostat is in the maximum position.	Reset the temperature of the remote control.
	Malfunctioning temperature probe.	Check the probe and replace it if necessary.
	Faulty or malfunctioning control panel.	Check the panel and replace if necessary.
The product does not switch on.	No power supply.	Check that the plug is inserted and the main switch is in the "I/ON" position.
	Fuse tripped due to a fault.	Replace the fuse with one of the same characteristics (5x20 mm T 3.15A).
	Check the brazier.	Clean the brazier and remove any deposits or residues of non-burned pellets.
	Check the position of the brazier.	Put the brazier back in its place.
	Check that the spark plug warms up.	Check and if necessary, replace.
	Clogged smoke outlet or smoke duct.	Clean the smoke outlet and/or the smoke duct.
	Faulty spark plug.	Replace the spark plug.

32-CIRCUIT BOARD

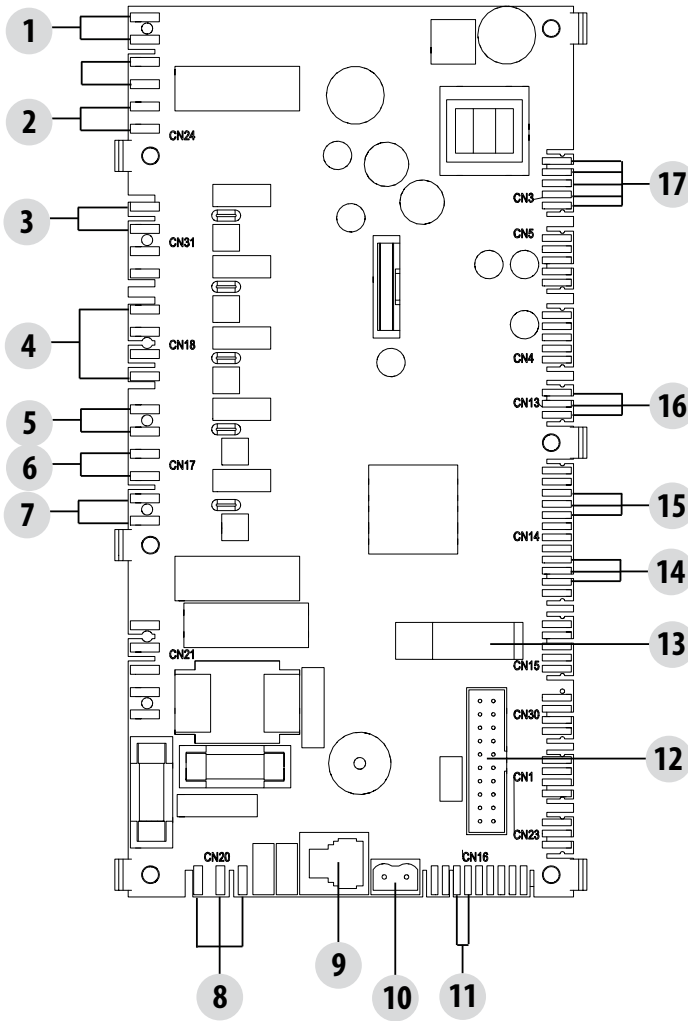

LIVE ELECTRICAL CABLES

DISCONNECT THE POWER
SUPPLY CABLE 230V
BEFORE CARRYING OUT
ANY OPERATIONS ON THE
ELECTRICAL BOARDS

KEY

- | | |
|---|-------------------------------------|
| 1. KLIXON | 9. MAESTRO CONTROL PANEL (OPTIONAL) |
| 2. AIR PRESSURE SWITCH | 10. SMOKE TEMPERATURE PROBE |
| 3. AIR FAN 3 (IF ANY) | 11. ROOM PROBE |
| 4. AIR FAN 2 (IF ANY)
ROOM FAN (FAN 1) | 12. EMERGENCY PANEL |
| 5. FEED SCREW | 13. SOFTWARE UPDATE (USB) |
| 6. SMOKE FAN | 14. SMOKE FAN ENCODER |
| 7. GLOW PLUG | 15. PRESSURE DIFFERENTIAL |
| 8. BOARD POWER SUPPLY | 16. PELLET SENSOR (OPTIONAL) |
| | 17. GEAR MOTOR |

PLEASE NOTE The electrical wiring of individual components is fitted with pre-wired connectors of different sizes.



MCZ GROUP S.p.A.

Via La Croce n°8

33074 Vigonovo di Fontanafredda (PN) – ITALY

Telephone: 0434/599599 a.s.

Fax: 0434/599598

Internet: www.mcz.it

e-mail: mcz@mcz.it